

# Evaluation of electron cloud measurements with the microwave transmission method of the MD run in week 39

S. Federmann, F. Caspers, E. Mahner

October 21<sup>st</sup>, 2010

- 1 New setup
- 2 Measurements
- 3 Results
- 4 Summary

- In the long intervention in week 39, the shielding of the pumping ports in magnets MB177 and MB289 were removed.
- Now active electronic components are not used anymore in the tunnel due to painful experiences with radiation damage (3 amplifiers lost). This also eliminates the need for bringing down DC supply voltage.
- This setup provided us with the possibility to increase the carrier signal on the one hand and to decrease the unwanted beam induced signals. These were one of the main causes of intermodulation distortion in the previous experimental setup.

- The new setup comprises one drive amplifier (+30 dBm output level) in the injector path (on the surface in BA5), as well as narrowband filters (at 2.7 GHz) and low noise amplifiers at the end of each receiver path (everything on the surface in BA5).
- A single coupling loop was used each for injection and pickup.

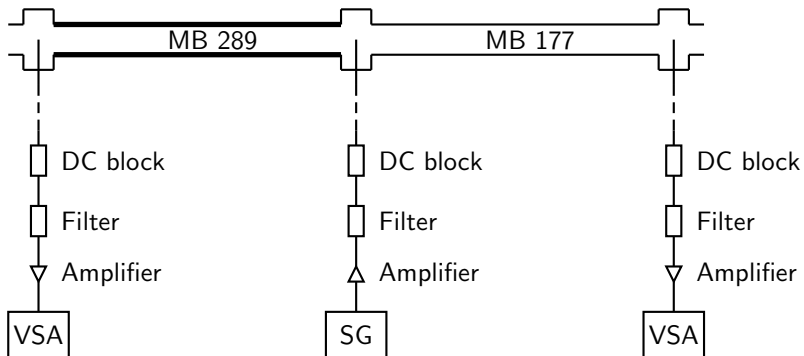

- According to the bandwidth of the used filters, a frequency around 2.71 was well suited for our measurements.
- Therefore we chose carrier frequencies of 2.71, 2.715 and 2.716 to estimate the best working frequency.
- In addition to the carrier, we sent down both an artificial AM and PM modulation created with our frequency generator at a frequency of 42 kHz.
- For all our measurements we used the first injection as a trigger signal.

- We still had problems with the short recording time of our Vector Spectrum Analyzer (VSA). Even long discussions with the manufacturer could not provide a satisfactory solution.
- Our measurements therefore were restricted to about 8s of data taking (filesize for **this type of recording** limited to 8.6 MB regardless of parameters). As a consequence we conducted our measurements at flat bottom only since we know from our previous experience that the signal is least disturbed in this region.
- Due to the short recording time unfortunately we can see two injections only. (in a few cases up to 3)

- We saw a large PM signal in the uncoated section (top graph), whereas (almost) no signal was visible in the coated section (bottom graph).

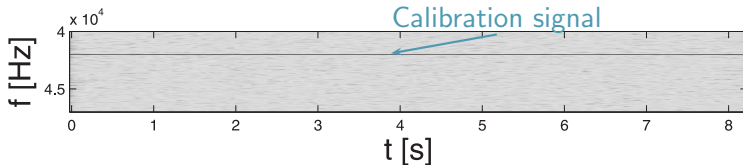
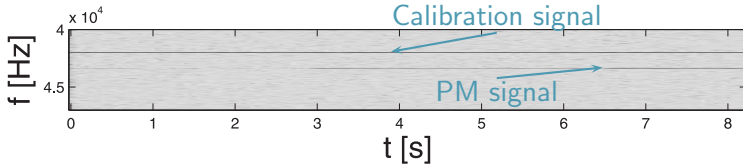

- We see an increase in the PM signal of roughly 5 dB with the second and 4dB with the third injection in the uncoated section.

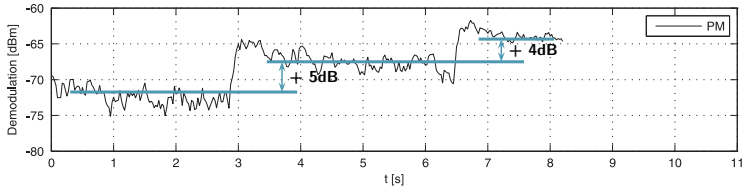

- Beam with 4 batches, 25 ns spacing and intensity of  $1.14 \cdot 10^{11}$



- This is independent of the number of batches and the used frequencies.

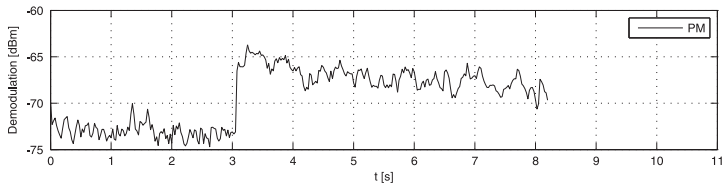

- Beam with 2 batches, 25 ns spacing and intensity of  $1.17 \cdot 10^{11}$

- In general, we see no signal at all in the coated section:

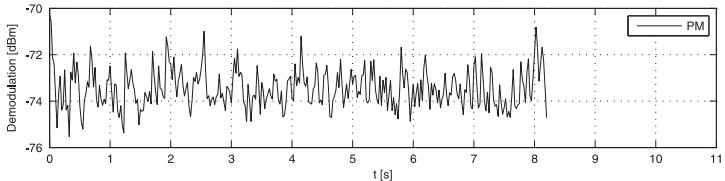

- Beam with 4 batches, 25 ns spacing and intensity of  $1.13 \cdot 10^{11}$

- Nevertheless in a few cases (4 out of 20) there is a very small increase in signal visible: maximum increase of about 0.5 dB after the second injection and a maximal increase of the signal of around 2 dB after the third injection:

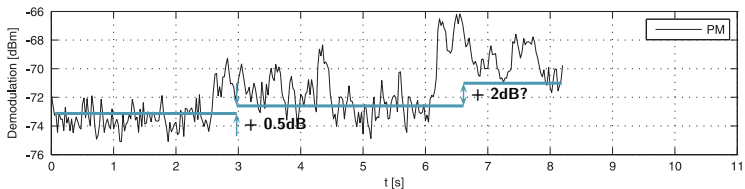

- Beam with 4 batches, 25 ns spacing and intensity of  $1.15 \cdot 10^{11}$
- In some cases (2 out of 20), an increase of roughly 1 dB after 3rd injection is visible.

- We see almost no ripple in the PM signal anymore.
- This is a strong indicator for a very 'clean' setup.
- In the AM traces, the injections are still visible:

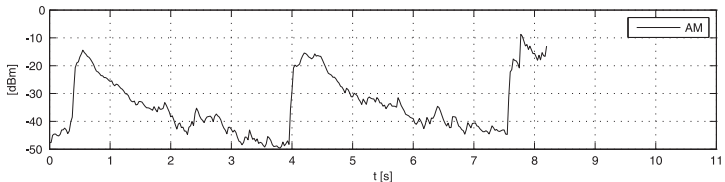

- Also the AM signal is dependent of the carrier wave (CW) frequency, whereas the PM signal is independent of the small frequency variations.
- We see the strongest AM signal at a frequency of 2.17 GHz and the lowest at 2.176 GHz. This is related to the different slopes in the HTF at these frequencies — a steeper slope causes a higher AM signal.

- Although we see a strong AM signal, the signals of PM and AM are not correlated anymore:

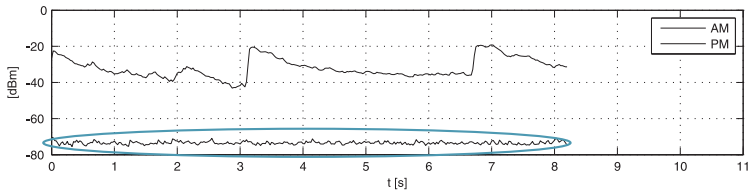
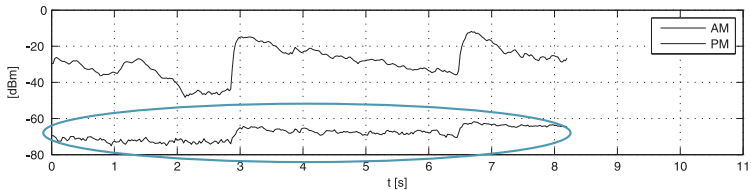

- We could in principle reproduce the findings of last years measurements.
- The new setup was shown to be reliable with at least the same dynamic range. It also facilitated our measurements considerably (access to all electronic components at any time).
- The beam induced signals seen by the electronics on the surface are reduced considerably (cable attenuation. narrowband filters) in this setup and as a consequence, we were not disturbed by beam induced intermodulation distortion. (neither 44 kHz directly induced on the cables nor spectral components above 1 GHz induced in coupling loops)
- The coated section shows almost no PM signal.
- The uncoated section showed an increase of about 5dB at the second injection and about 4dB at the third injection.
- However, we still have to analyze the data from this weeks MD.