

Electron Cloud Measurements

F. Caspers, S. Federmann, E. Mahner, D. Seebacher

Contents

- Motivation
- Theoretical expectations
- Experimental Setup
 - Design considerations
 - Installations in the tunnel
 - Electronics on the surface
- Crosschecks and calibration
- Measurements

Motivation

- Electron cloud limits beam intensity and beam quality at high currents
- Coating of the beam pipe might reduce electron cloud
- Present method (microwave transmission method) is suitable to measure **integrated electron cloud density** over transmission length (other methods (e.g. shielded buttons) measure only point like)
- done via measuring phase modulation (PM) of transmitted wave

Theoretical Expectations

- Expected phase difference between injected and received signal can be calculated¹ via

$$\Delta\varphi = \frac{L\omega_p^2}{2c\left(\omega^2 - \omega_c^2\right)^{\frac{1}{2}}}$$

ω_p Plasma frequency
 ωInjected frequency (f = 2.68 GHz)
 ω_c Cutoff frequency (f = 1.23 GHz)
L.....length of transmission path (6.5 m)

- $\Delta\varphi$ is proportional to the electron cloud density:

$$\omega_p \cong 56.4\sqrt{n_e} \quad n_e \dots \text{electron cloud density} \approx 10^{12}$$

- Expect a phase difference of $\Delta\varphi = 2.3 \cdot 10^{-3}$ rad

Experimental Setup

uncoated/coated

coated/coated

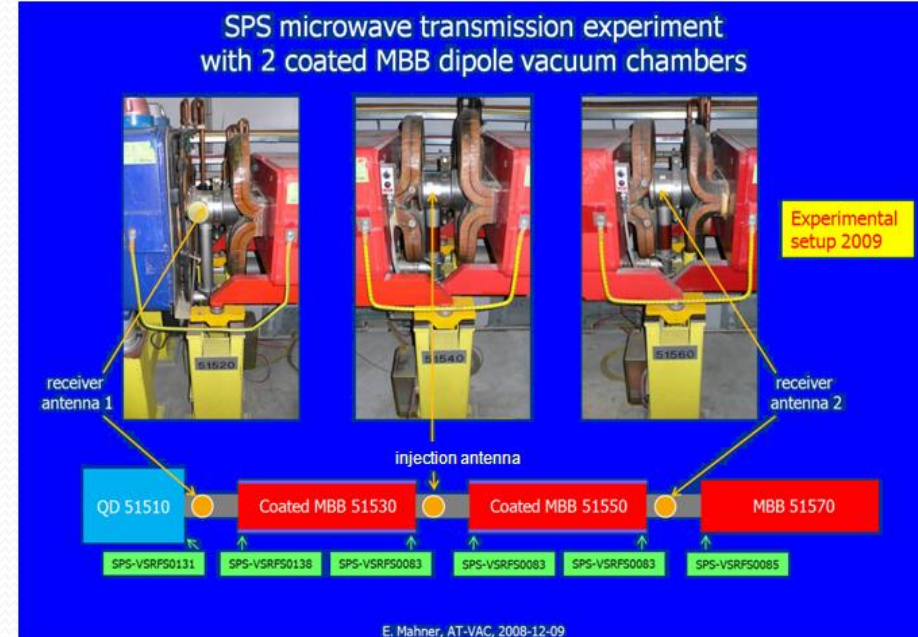
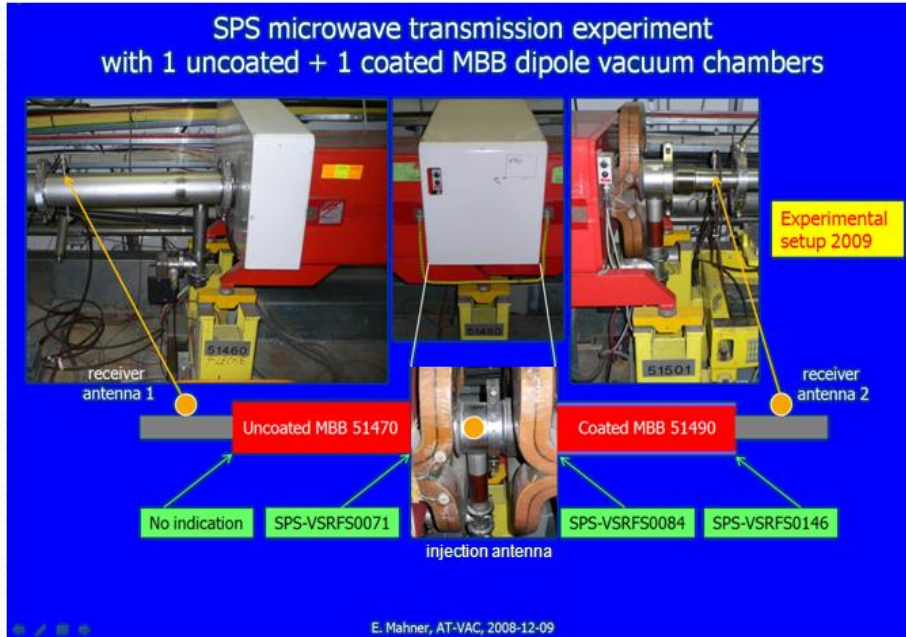

→ In total we have 4 measurement sections

Design Considerations

Requirements:

- Severe space constraints (upper picture)
- Need to fit pick ups through two walls through two walls (beam pipe and RF shield – lower picture)
- Minimization of beam induced signals
- Fairly easy and reasonably fast production and implementation of the pickups



Modification of MBB pumping ports and shielding

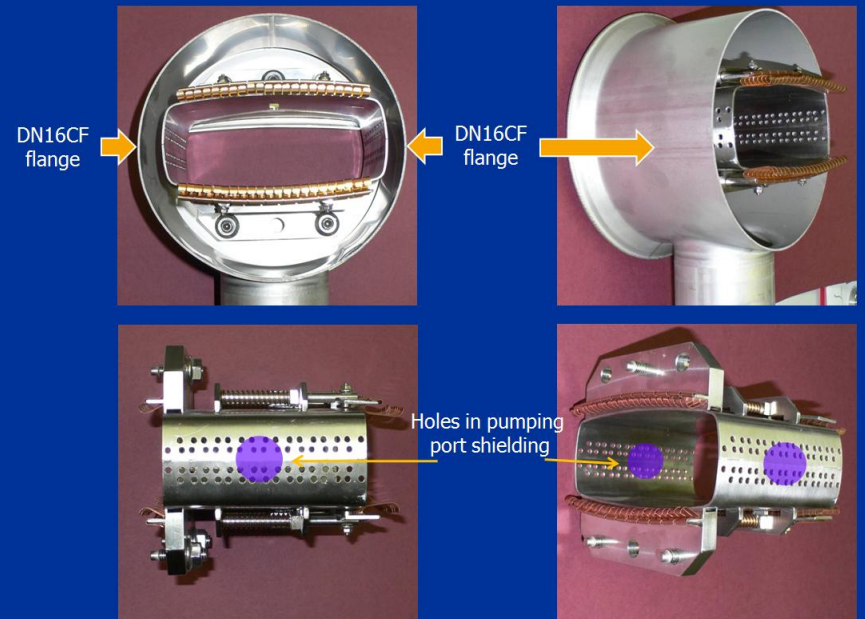

Experimental Setup

Schematic drawing of the setup used in the 2 different (coated/ uncoated) beam pipe sections

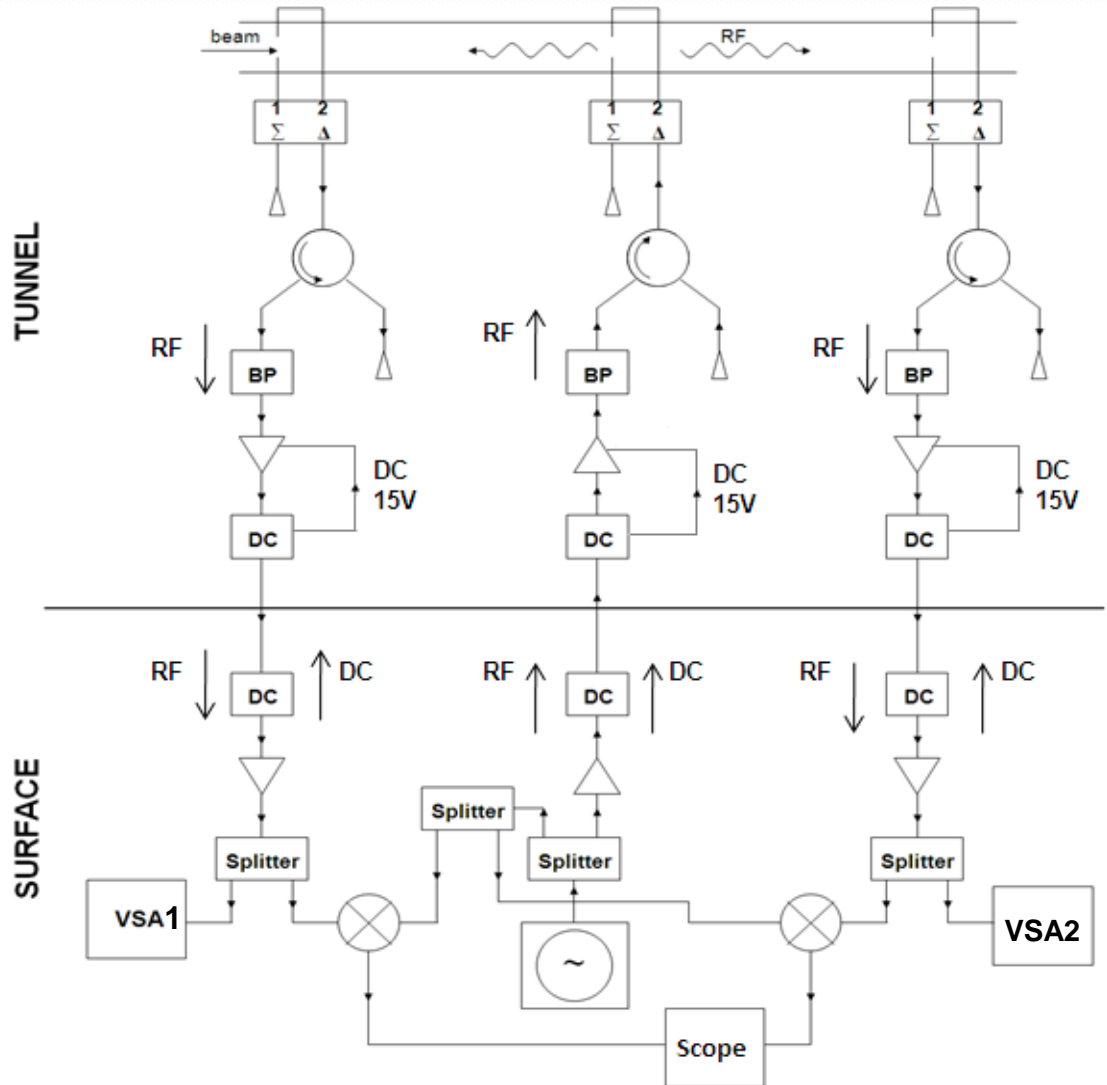

Experimental Setup

Antennas and buttons used for the SPS
microwave transmission experiment (loops
in 5 locations = 10 loops)

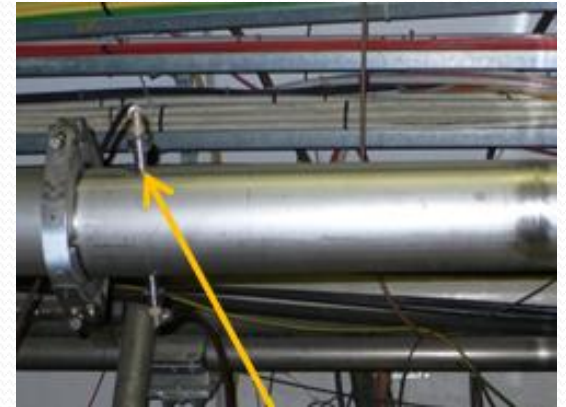

Buttons (not loops!) used in
one location only

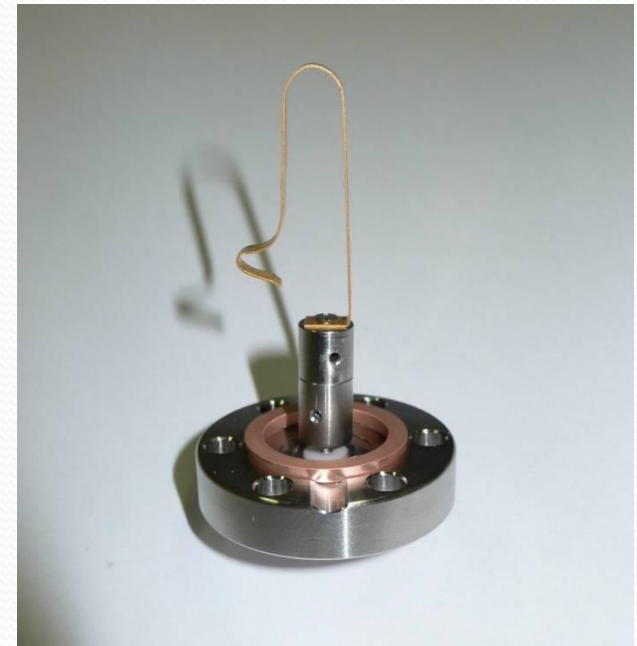

Visualization of fields and wall currents in a rectangular waveguide (TE₁₀)

Magnetic field pattern TE₁₀

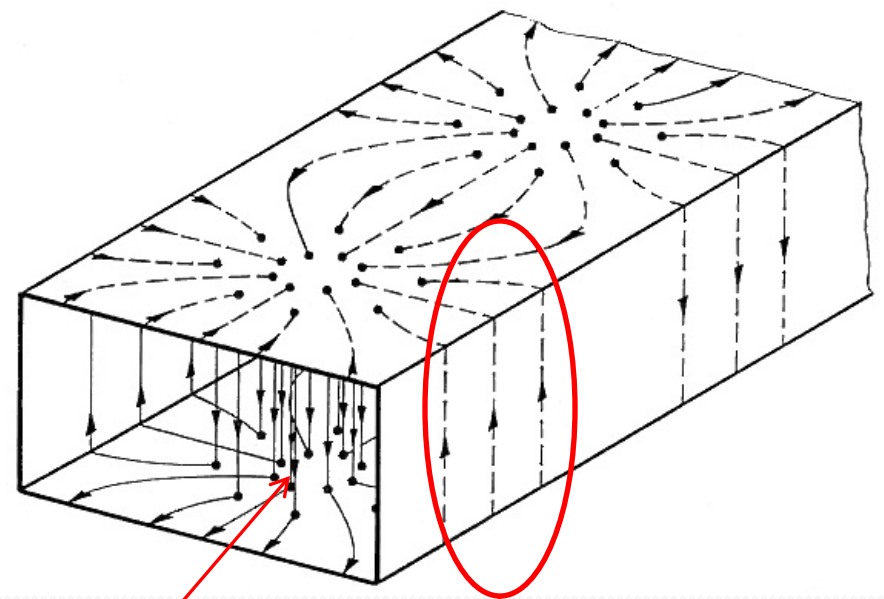
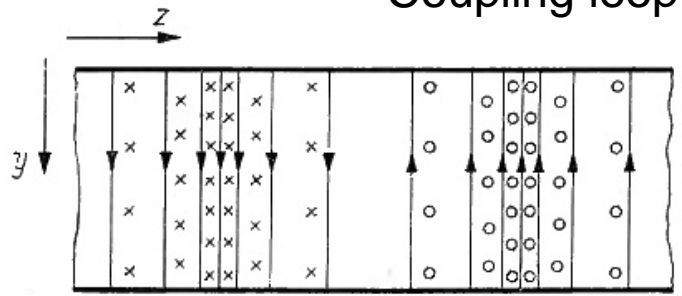
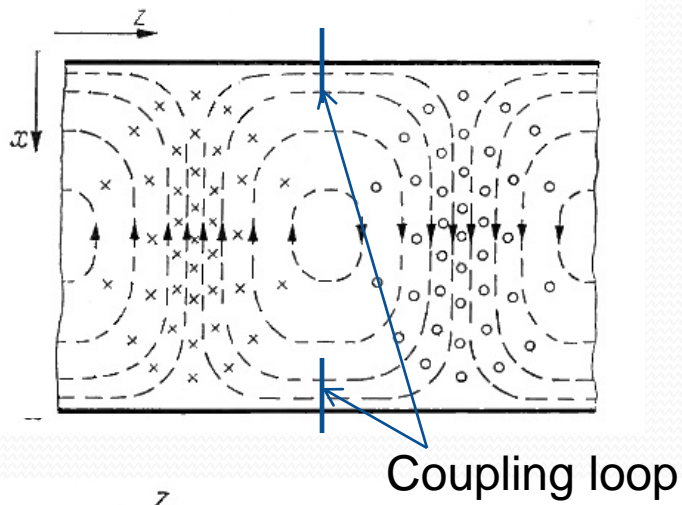

Electric field (displacement current) continuous as wall current and forms closed circles

We have to give the lateral coupling loops an orientation such that they have to interact with the component of the magnetic field in direction of propagation

Experimental Setup

Buttons located on top and bottom:

- Couple essentially electrically and E field of the preferred mode (TE_{10}) is highest there
- See a lot of beam induced signals because they are close to the beam
- If the beam is not exactly centered, those picked up signals cannot be suppressed entirely even when operating in the differential mode (button BPM effect)

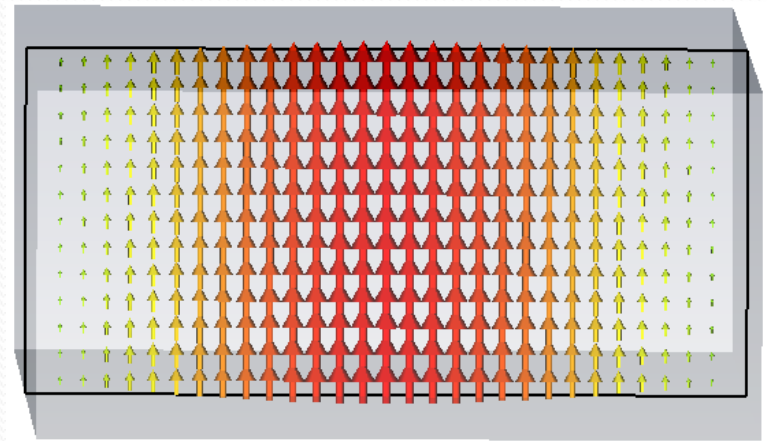

E field of the TE_{10} mode

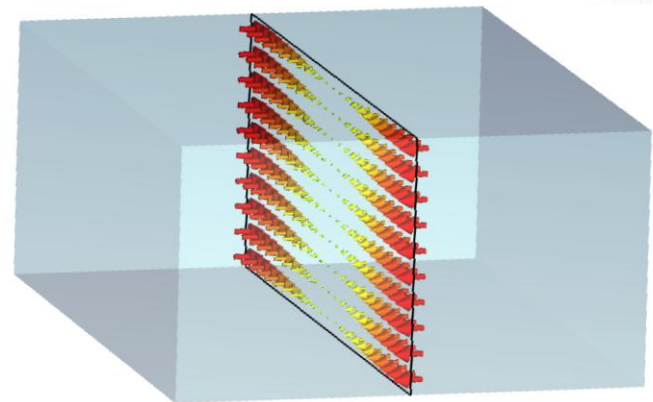

H field of the TE_{10} mode

Experimental Setup

Loop couplers:

- At the lateral (short) side of the waveguide we have low (vanishing) tangential electric field but the maximum of the tangential magnetic field for the TE₁₀ mode
- Loops couple magnetically to the preferred mode (TE₁₀)

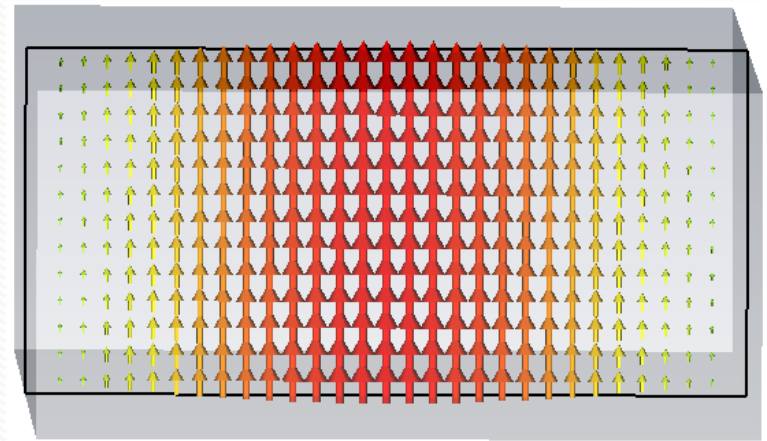

E field of the TE₁₀ mode

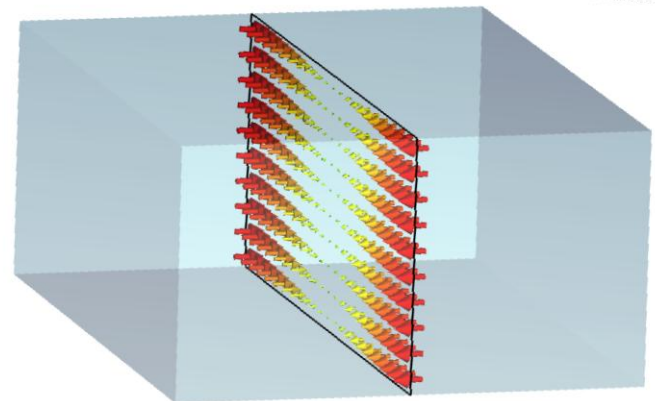

H field of the TE₁₀ mode

Experimental Setup

Also TEM like field of beam has already decayed considerably

Simplified cross section of AA stack-tail pick-up

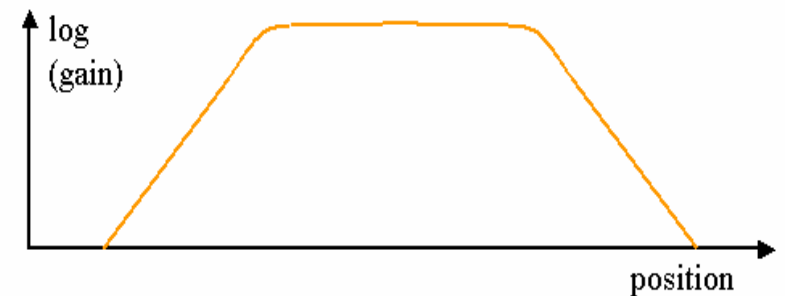
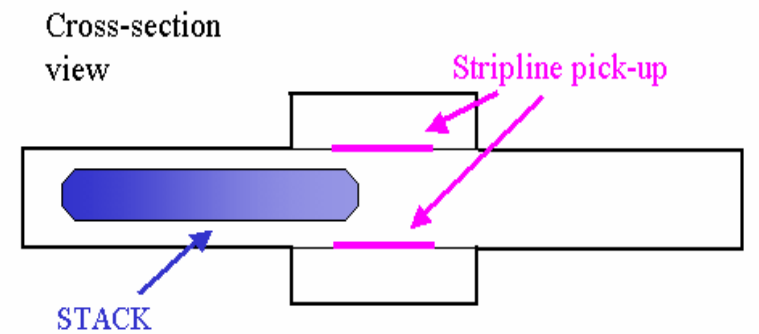

Gain is roughly proportional to the electric or magnetic component of the TEM like beam field

Experimental Setup

- At one location buttons are installed, but there beam pipe has cylindrical cross section of 100 mm (from previous version of the experiment in 2008), there was no possibility to install loops in the same way as on the other pumping ports
- At all other locations antennas were used to couple magnetically on the short side of the waveguide
- Were adjusted in same direction -> the difference of both signals had to be used since induced currents on each side have a phase difference of 180 degrees – was done using hybrids

Electronics in the Tunnel - receiver path

Hybrid

- provides differential signal for TE₁₀ waveguide mode
- Theoretically, there should be no coupling to the TEM beam mode, however beam always induces waveguide modes at discontinuities (wake field) and those modes couple
- Additionally, loop couplers are not perfect, couple also electrically to a certain extent
- terminated at sum port via 50 Ω termination

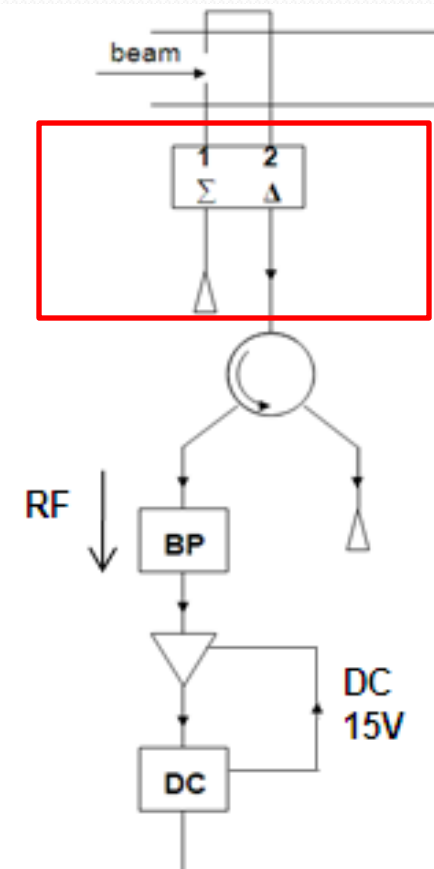
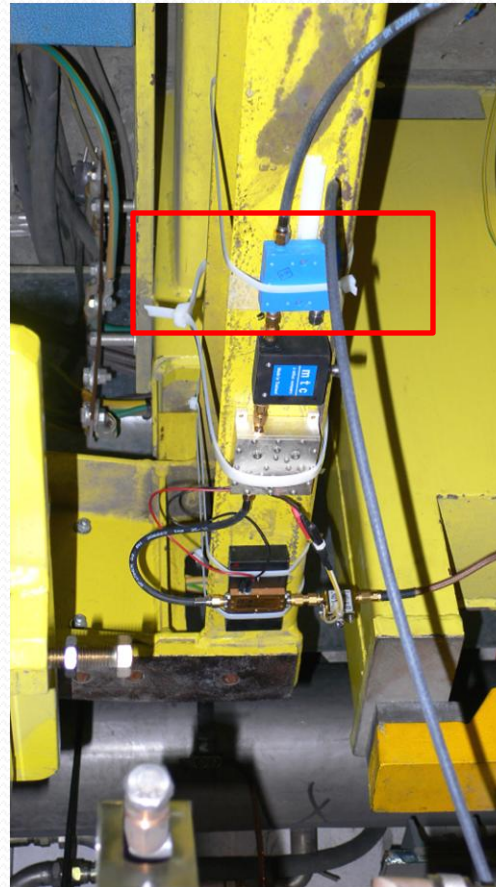

Electronics in the Tunnel - receiver path

Circulator

- Terminated at one port via 50Ω termination
- Terminates the band pass filter on one side, since this filter can only work properly if it is terminated on both sides (on the other side it is terminated via amplifier)
- In case of button pick-ups the circulator also functions as DC return (loop couplers are grounded via beam pipe)

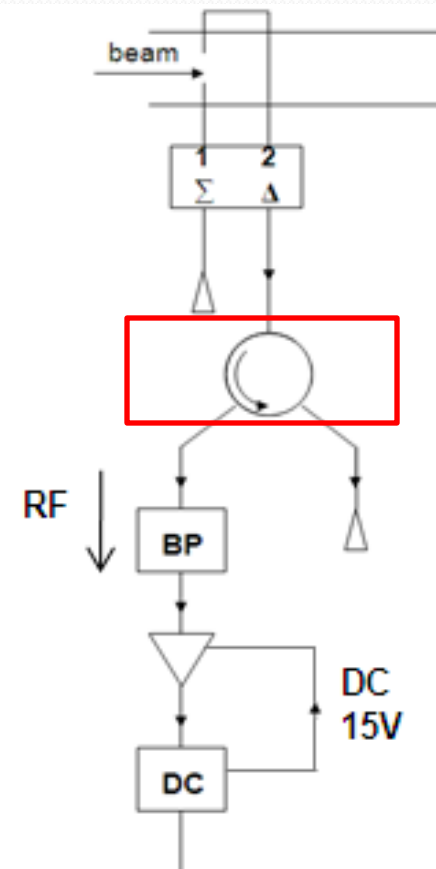
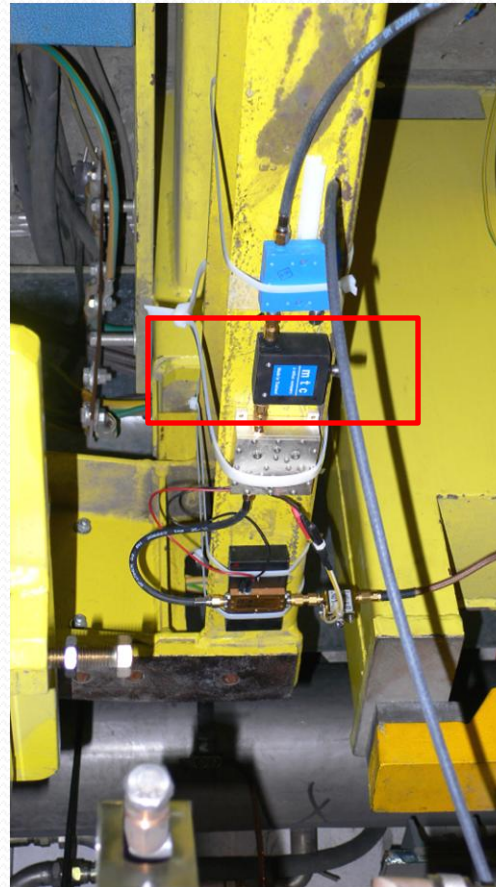

Electronics in the Tunnel - injector path

Circulator

- Terminates band pass filter as well
- Provides protection of transmitter amplifier from beam induced signals in antenna

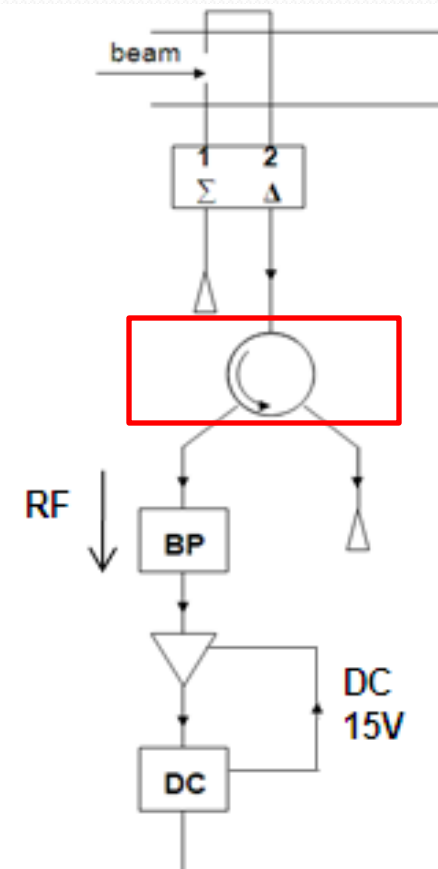
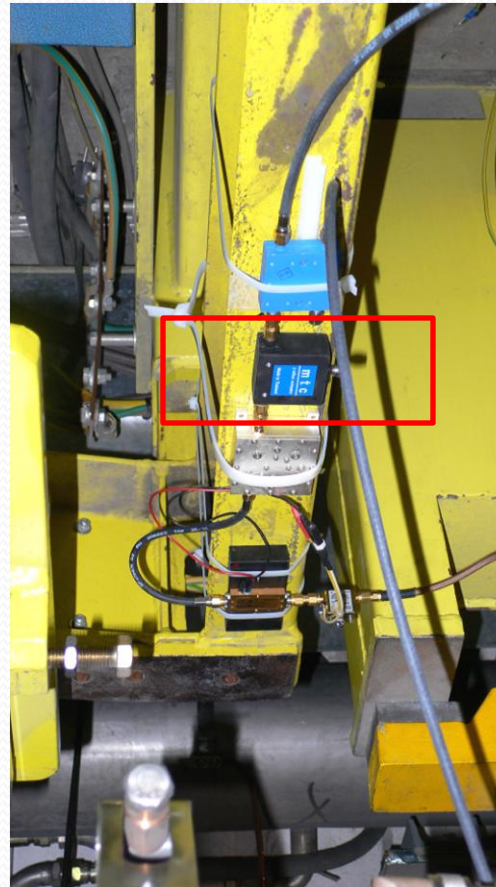

Electronics in the Tunnel - receiver path

Filter (in the picture the old one around 2.5 GHz is shown)

- We have used single cell cavity filters made in CERN workshop because after installing coupling loops it turned out that reasonable good transmission maximum in the HTF (hardware transfer function) at 2.68 GHz (2.5 GHz before) \rightarrow could not use old ones
- Could not know for sure, that filters ordered from industry arrived in time (in fact they were late) \rightarrow used home made ones

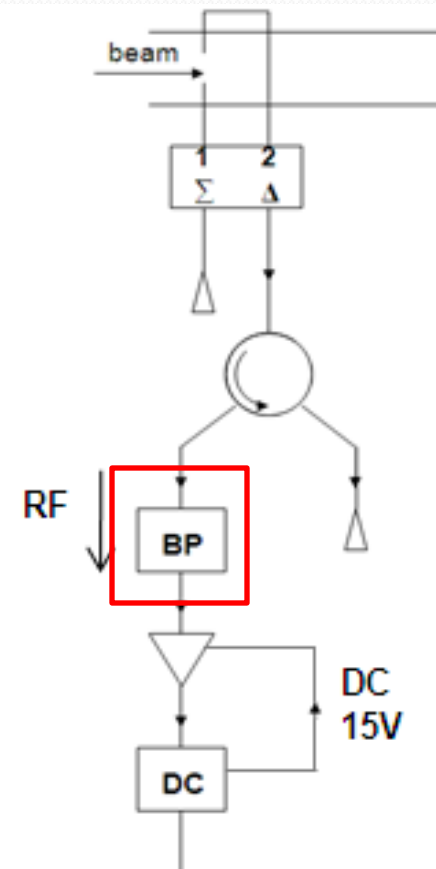
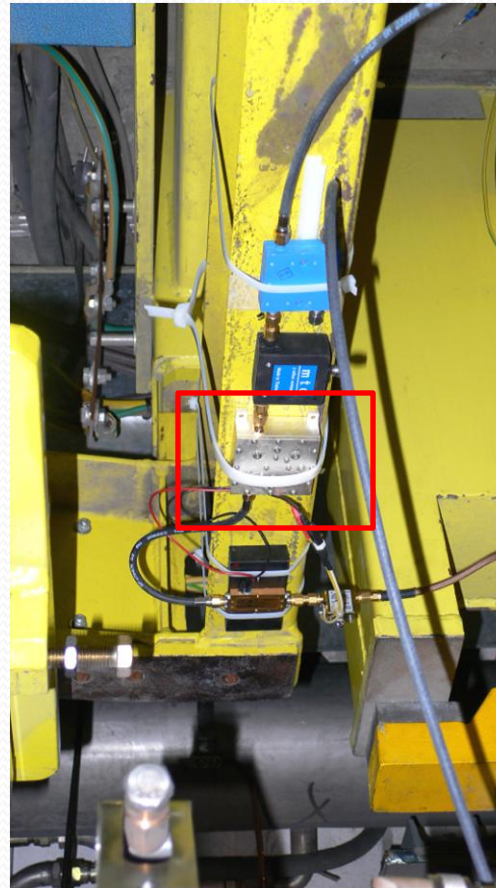

Electronics in the Tunnel - receiver path

Amplifier and DC bypass (DC feed)

- Wanted to minimize active electronics such as power supplies in the tunnel → risk of radiation damage
- Could have also provided additional cables but that would have been more expensive
- Working principle of DC bypass:

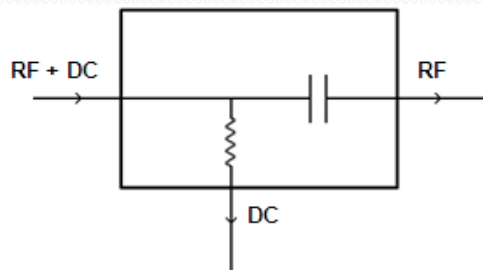

- DC feed: commonly used e.g. for any terrestrial TV or satellite receiver unit

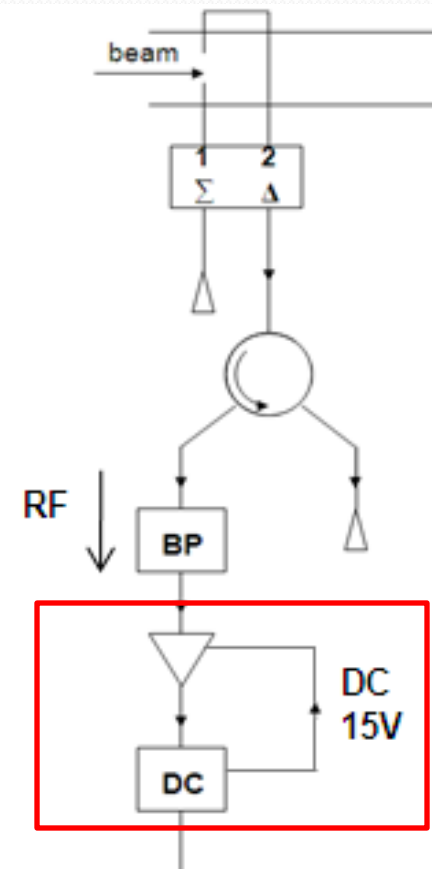
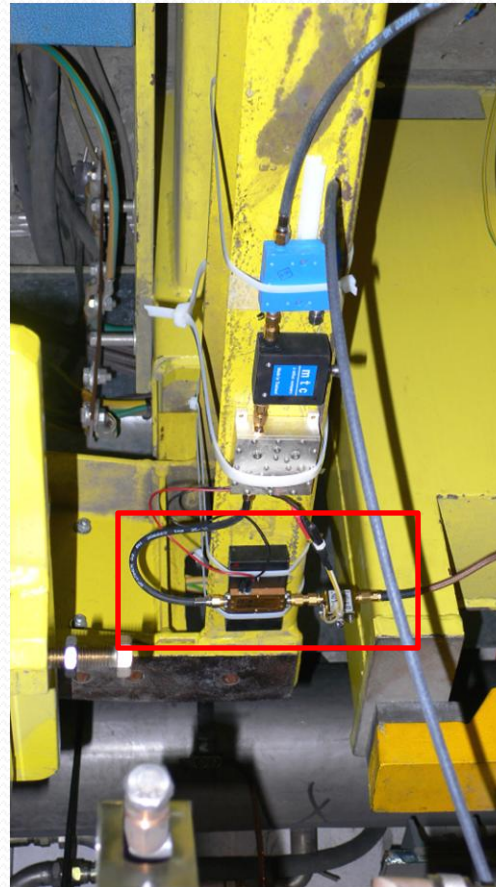

Electronics on surface

Have DC bypass and amplifier as used in the tunnel

Injector path:

- signal generator transmits CW generator signal (2.68 GHz) to a signal divider (splitter)
- One part of the signal goes down to the tunnel
- The other part is needed later as LO signal in the mixers (used as phase detectors)

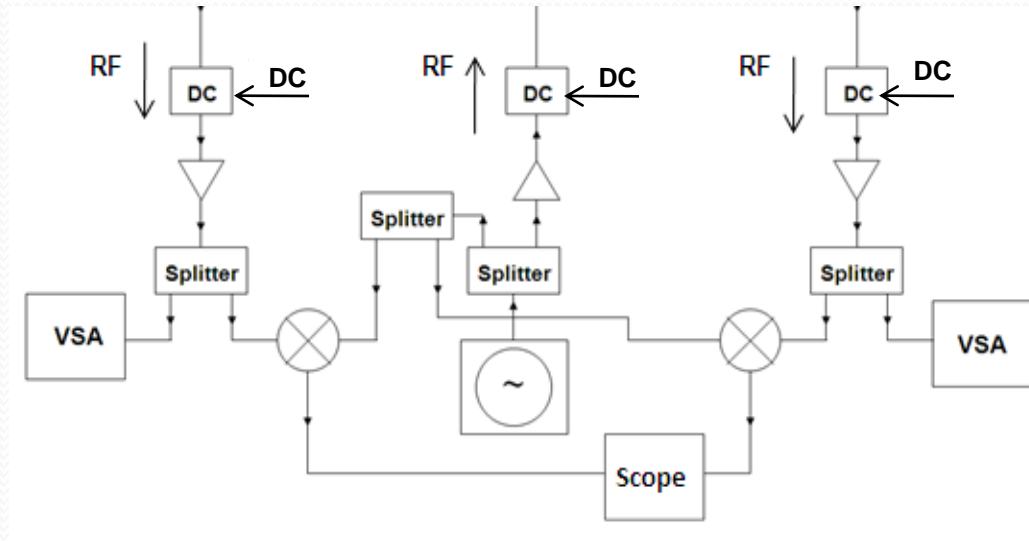

Receiver path:

- Signal is splitted after amplification
- One fraction of this signal arrives at the VSA for analysis
- The other fraction is used later as RF in the mixers

AM and PM Modulation

- In general we have three types of modulation:
 - Pure amplitude modulation (AM)
 - Pure phase modulation (PM)
 - Mixture of AM and PM
- In case of a sinusoidal modulation function AM and PM differ in sign in the lower sideband:

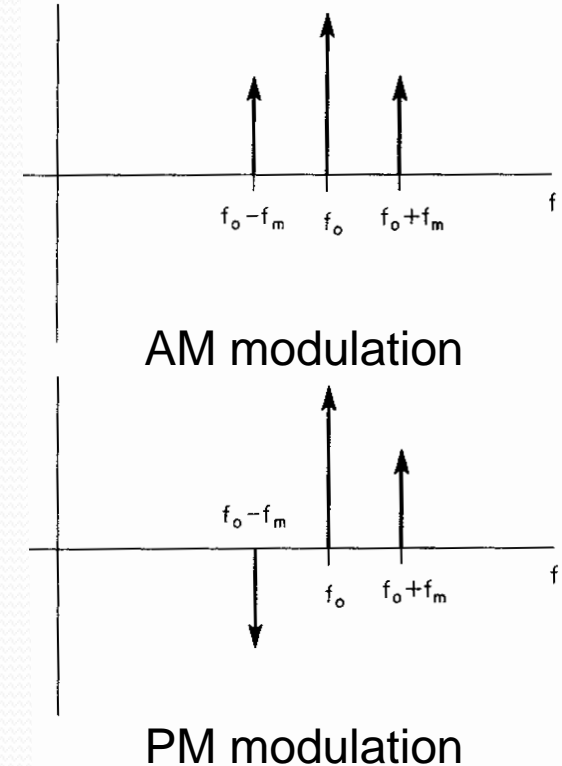

$$\text{AM: } v(t) = A_c \cos(2\pi f_c t) + \frac{aA_c}{2} [\cos 2\pi(f_c + f_m)t + \cos 2\pi(f_c - f_m)t]$$

$$\text{PM: } v(t) = A_c \cos(2\pi f_c t) + \frac{A_c\beta}{2} [\cos 2\pi(f_c + f_m)t - \cos 2\pi(f_c - f_m)t]$$

A_cAmplitude of carrier signal, f_cFrequency of carrier signal, f_mFrequency of modulation signal

Example for pure AM Modulation

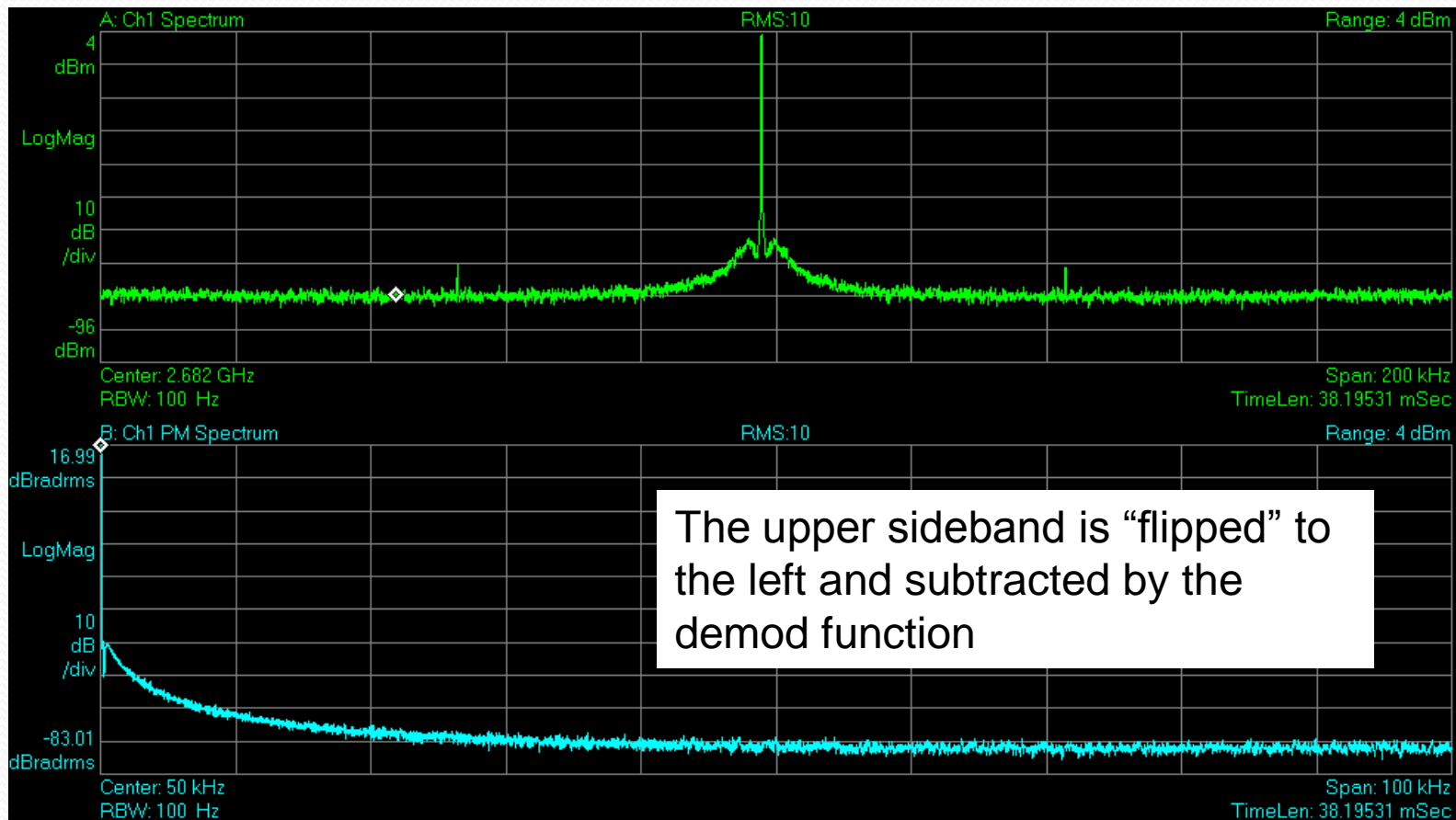

Lower trace (blue): signal after demodulation (note: different span)

AM and PM Modulation

- When we have both (AM + PM) the sidebands have a different height as the two graphs add as vectors:

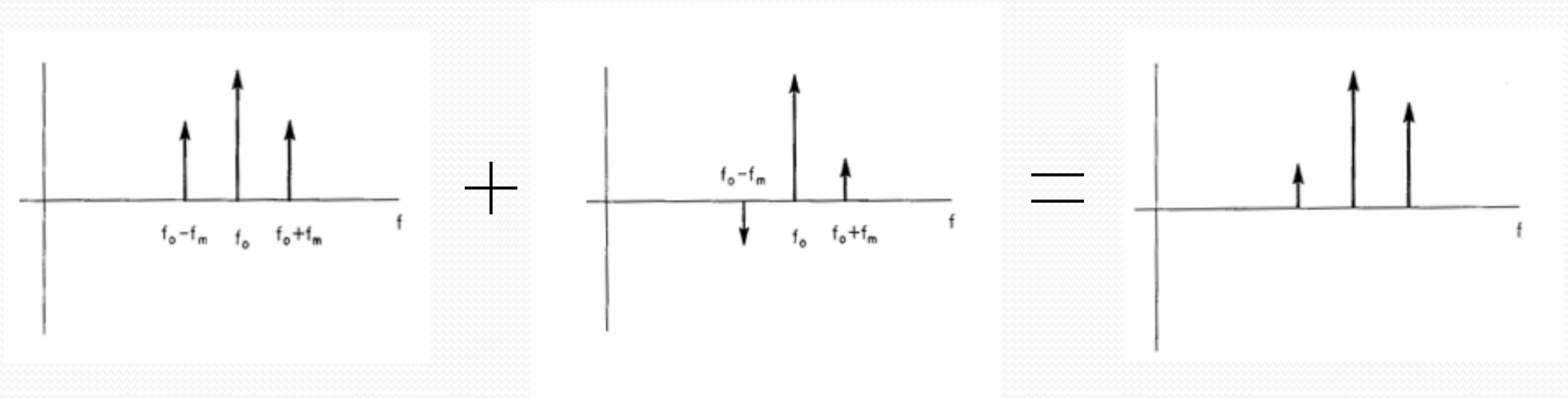

AM and PM Modulation

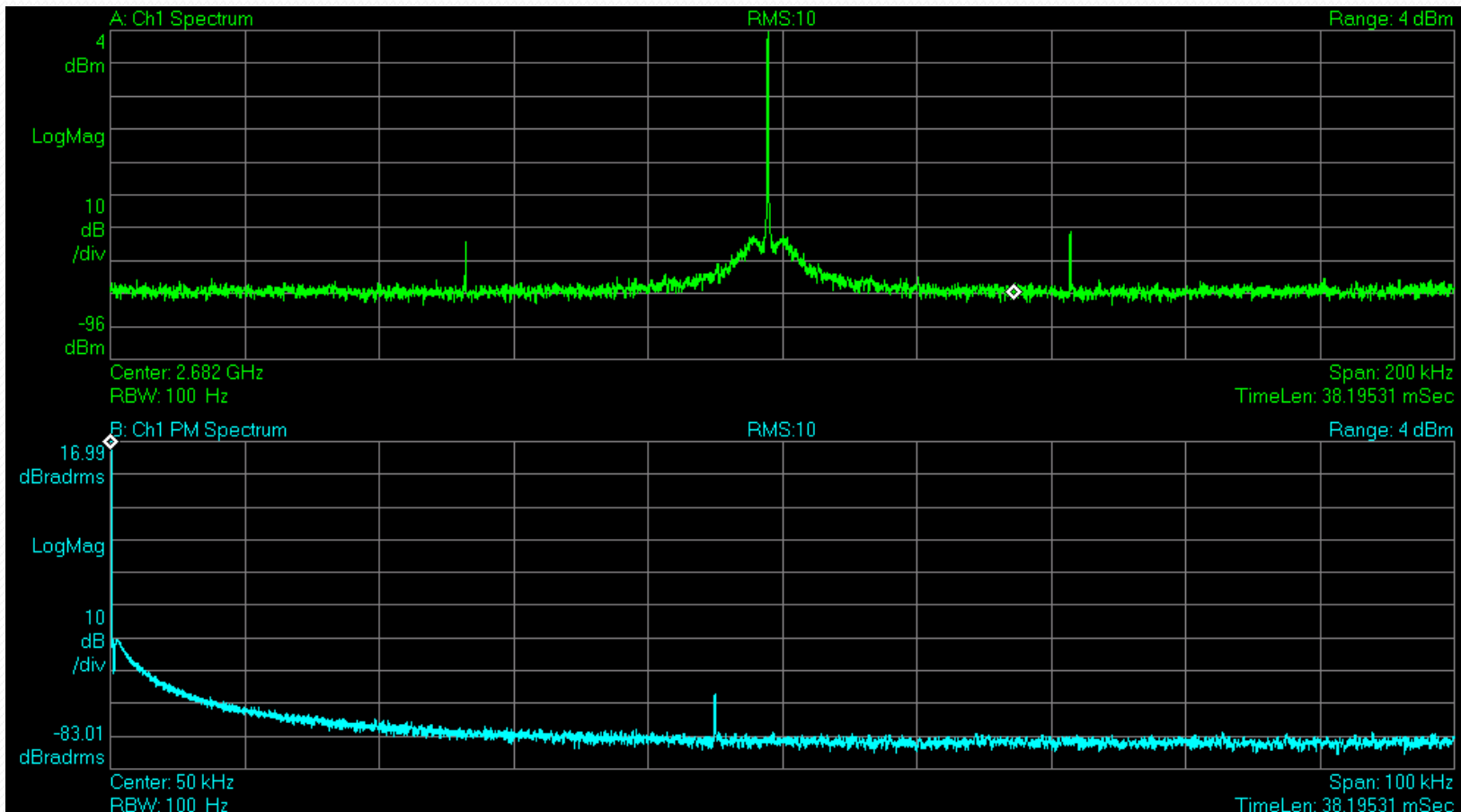

Lower trace (blue): signal after demodulation (note: different span)

Hardware Transfer Function (HTF), Filter

Typical transmission response of filters in use

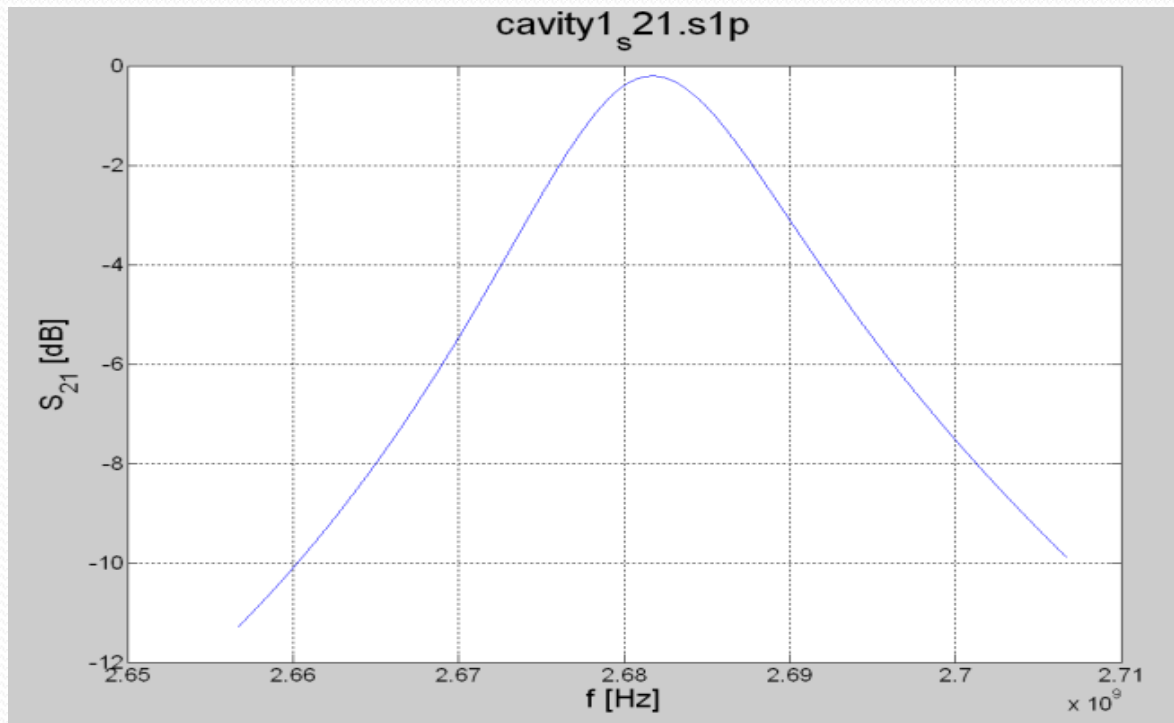

$f_c = 2.682042$ GHz
BW = 16.234 MHz
Q = 165.19

Hardware Transfer Function (HTF)

HTF of a complete loop:

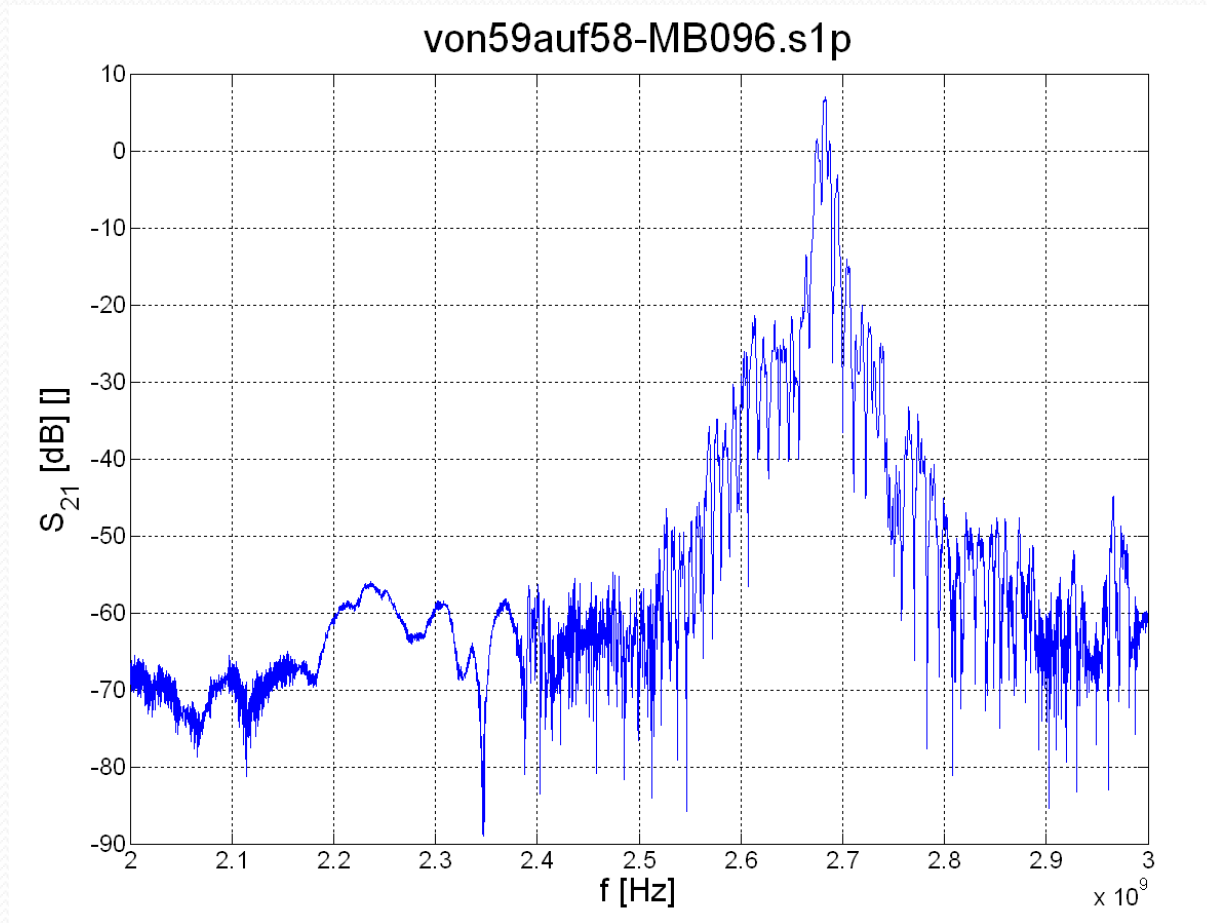

Example of measured signal traces

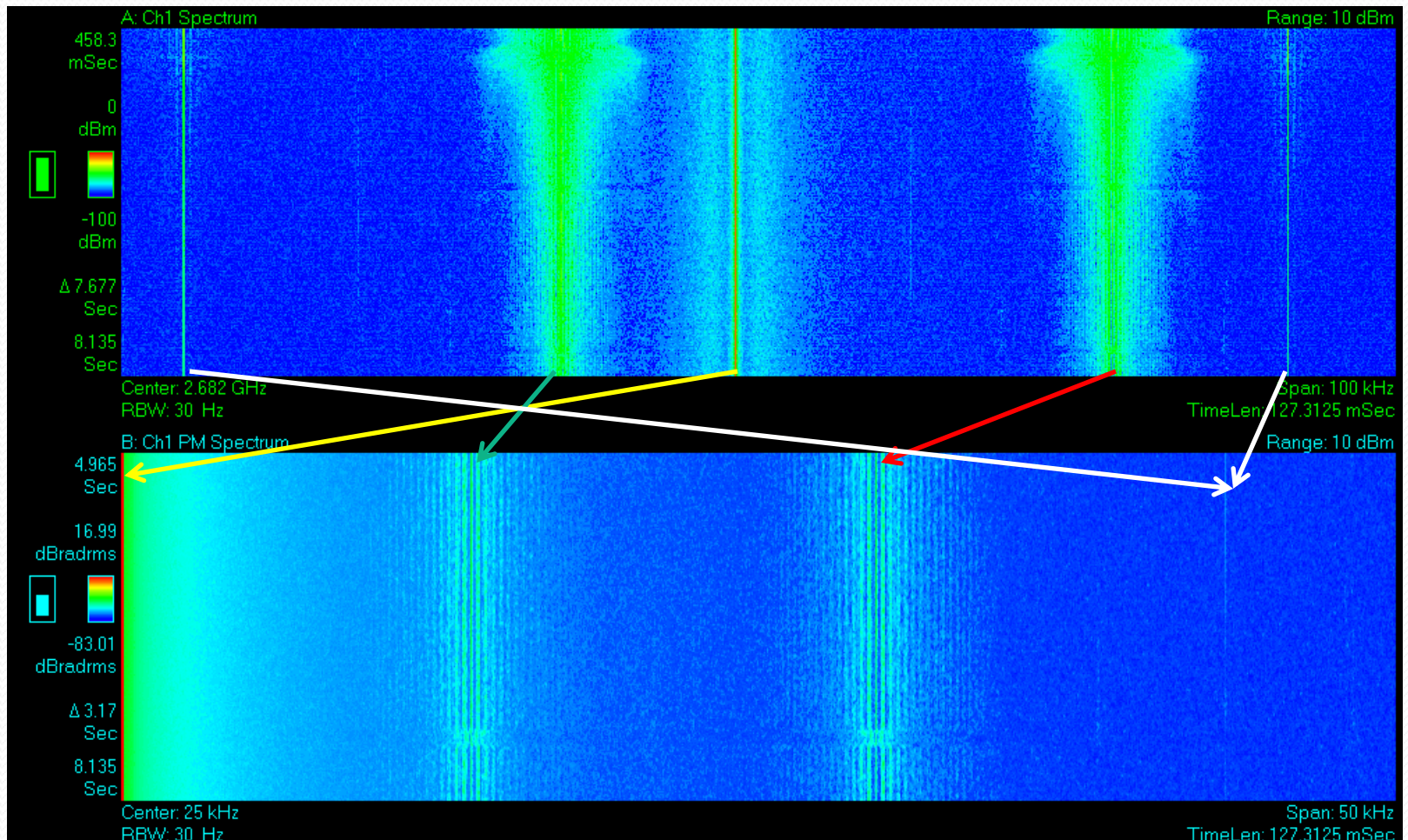

Cyclenr: 4971 , 16.6 2009

Before scrubbing Tuesday afternoon (16.6.09)

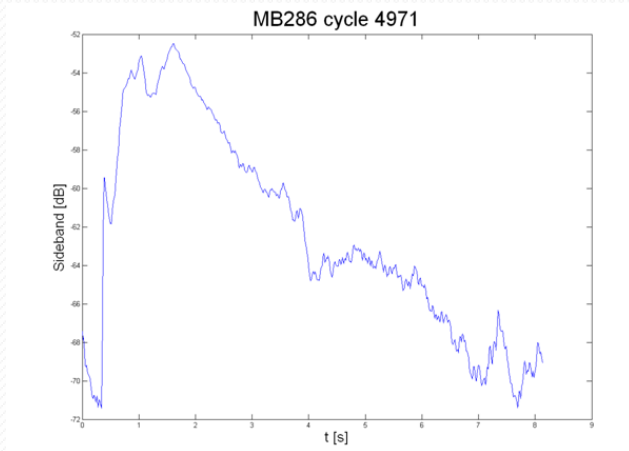

uncoated

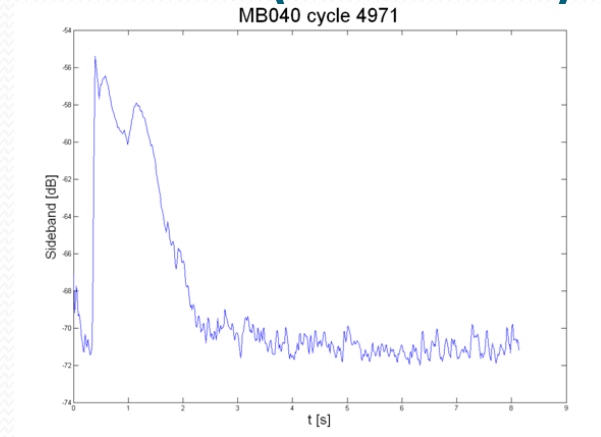

coated

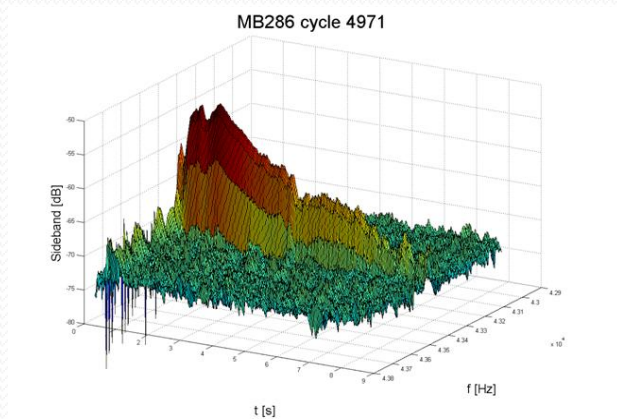

uncoated

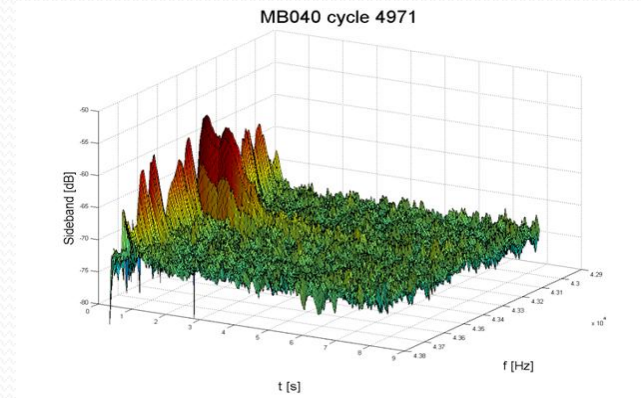

coated

Beam: 1 batch with 72 bunches

Before scrubbing Tuesday afternoon (16.6.09)

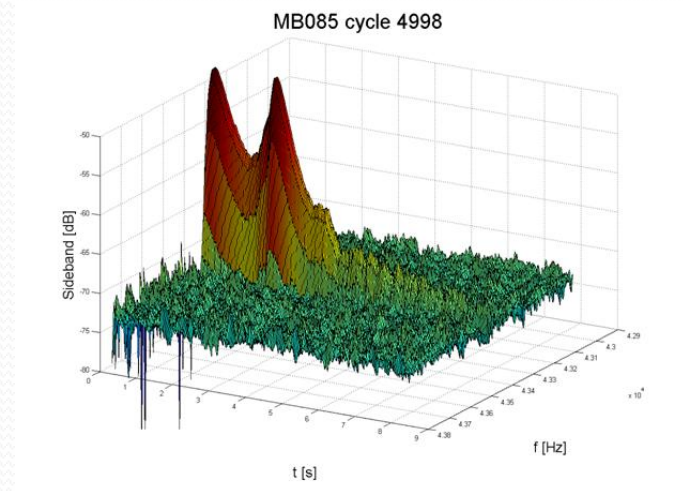
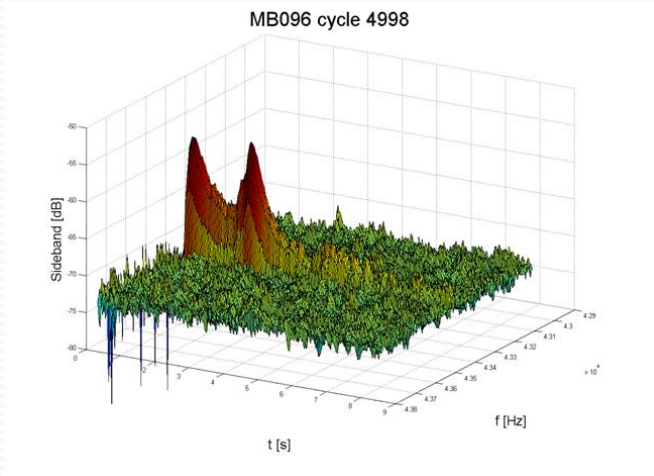
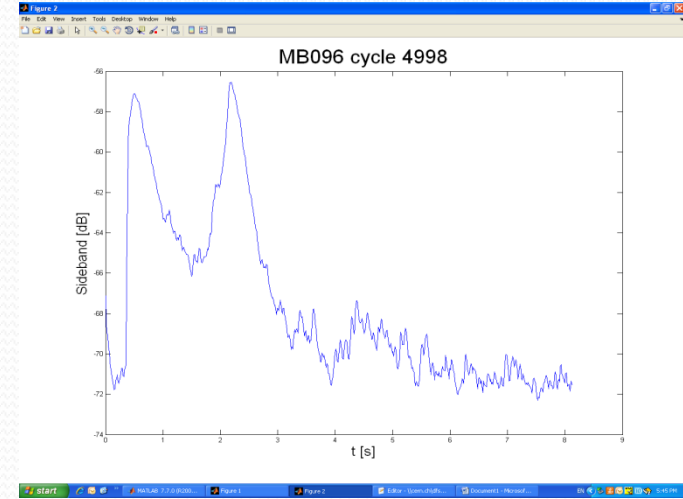
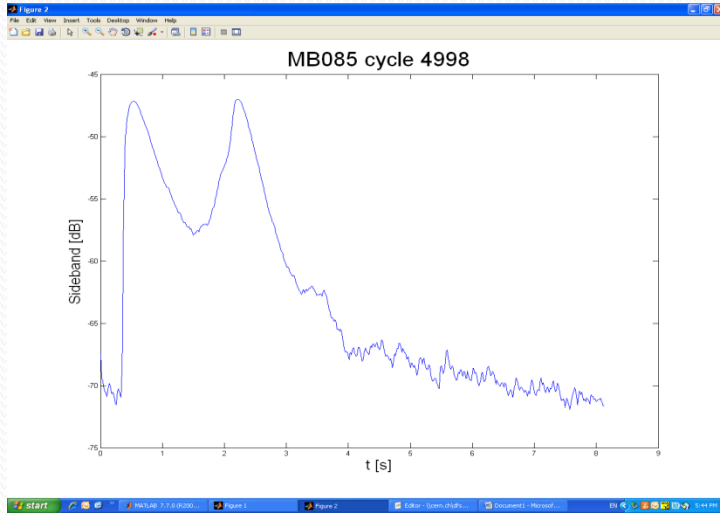

After scrubbing Wednesday night (17.6. 09)

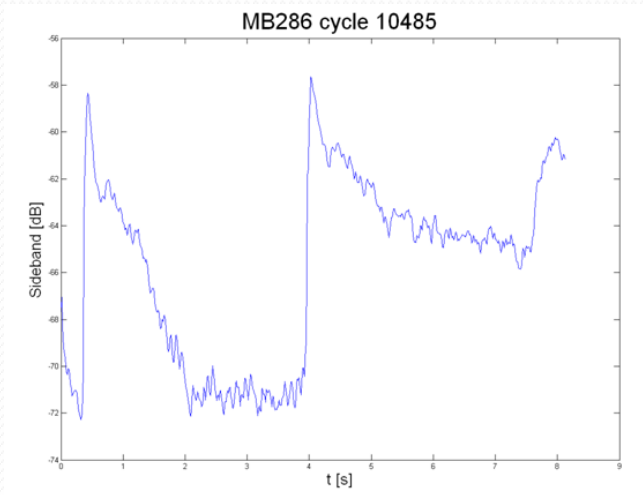

uncoated

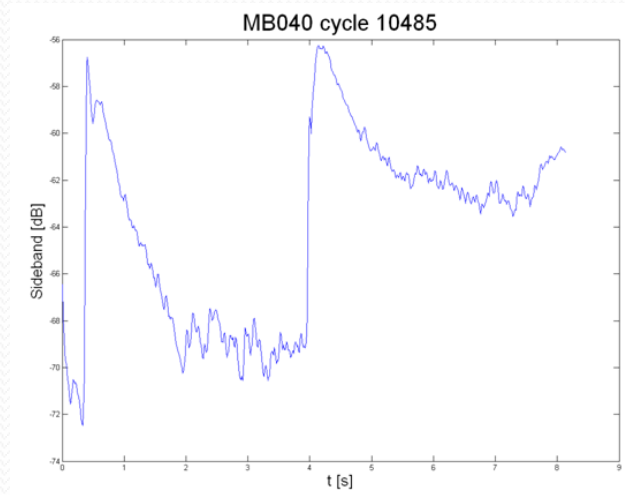

coated

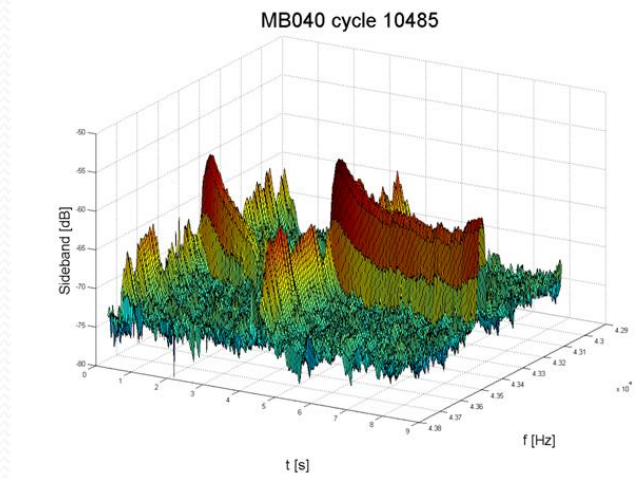
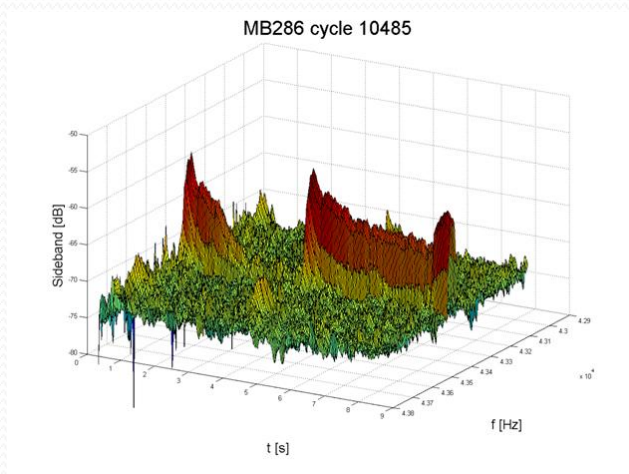

After scrubbing Wednesday night (17.6.09)

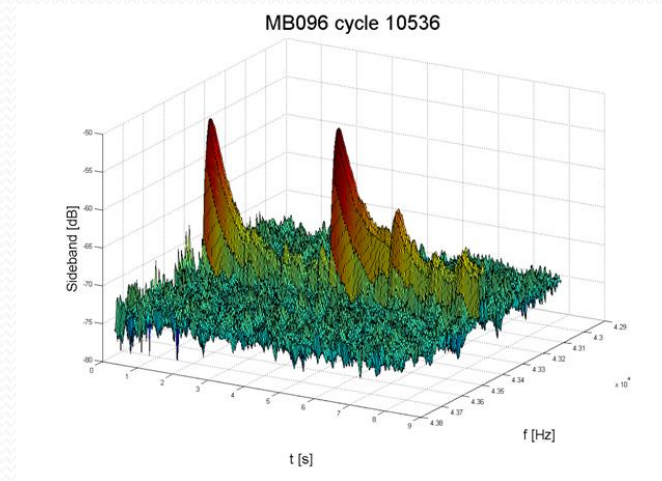
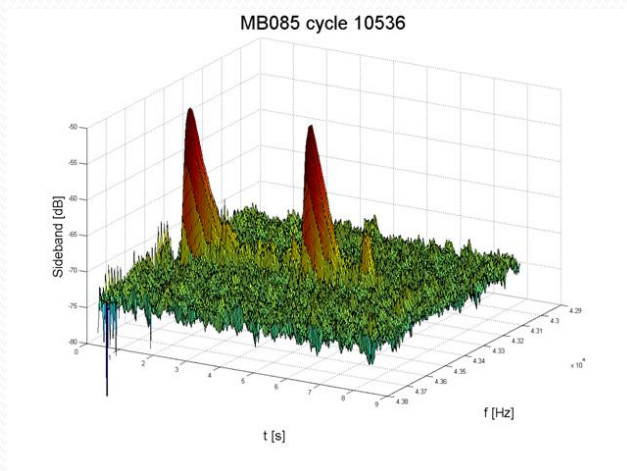
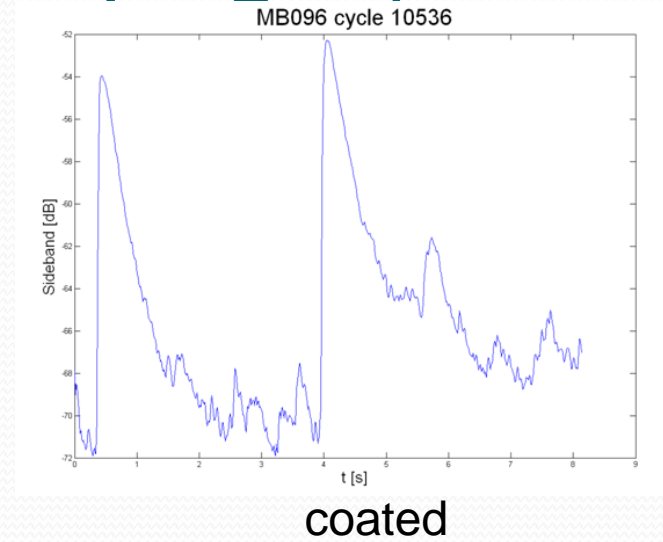
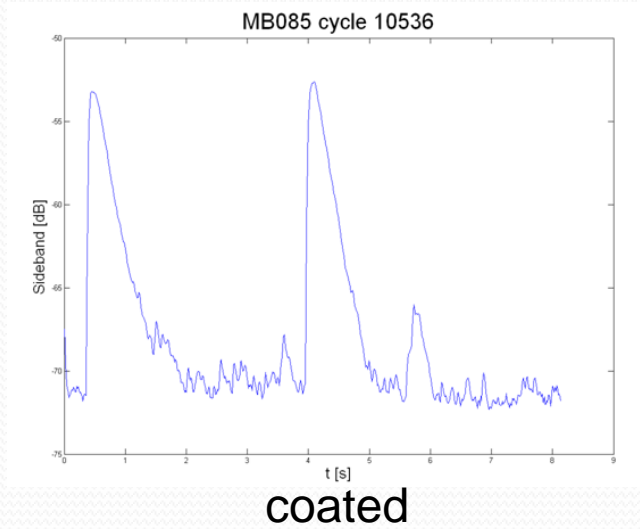

Segment 2

- Coated magnet
- Beam: 1 batch with 72 bunches

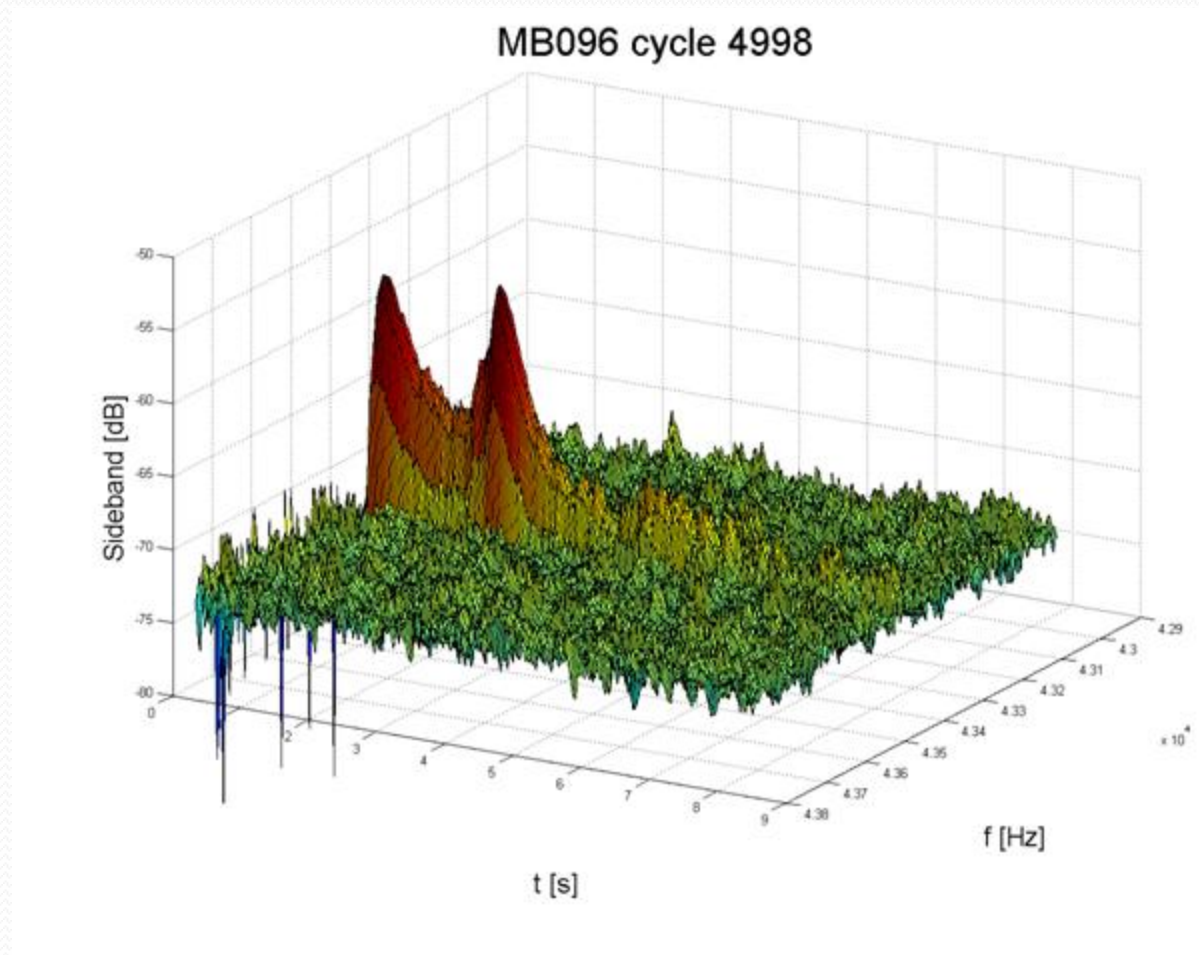

Observation

- PM in case of coated/uncoated magnets not too different
- Idea of possible contamination via supply voltage of the amplifiers
- Tested by inducing a signal at 44 kHz -> see same effect!
- Contamination causes AM/PM conversion larger (?) as the wanted PM by beam
- Not resolvable since we are looking for very small signals

Phase shift caused by magnet ramp

- The figure shows the low pass measurement results presented in preliminary talk
- It can be seen that there is a phase shift corresponding to the magnetic field

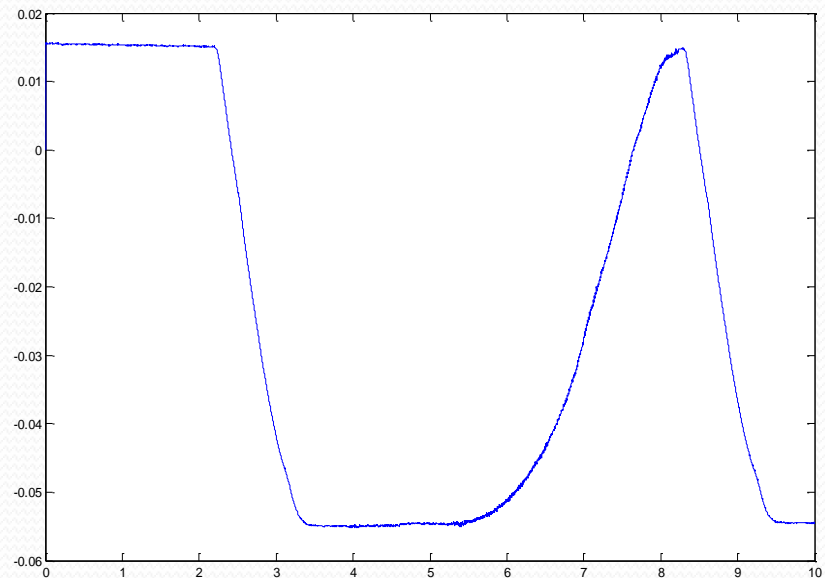

May caused by magneto restriction of the magnets and liners following small cutoff and furthermore phase shift

Supply voltage AM modulation test receiver

- Additional to the supply voltage a 44KHz signal with 1Vpp was applied at the surface
- The influence on transmission, especially phase was of interest
- No visible influence at the receiver

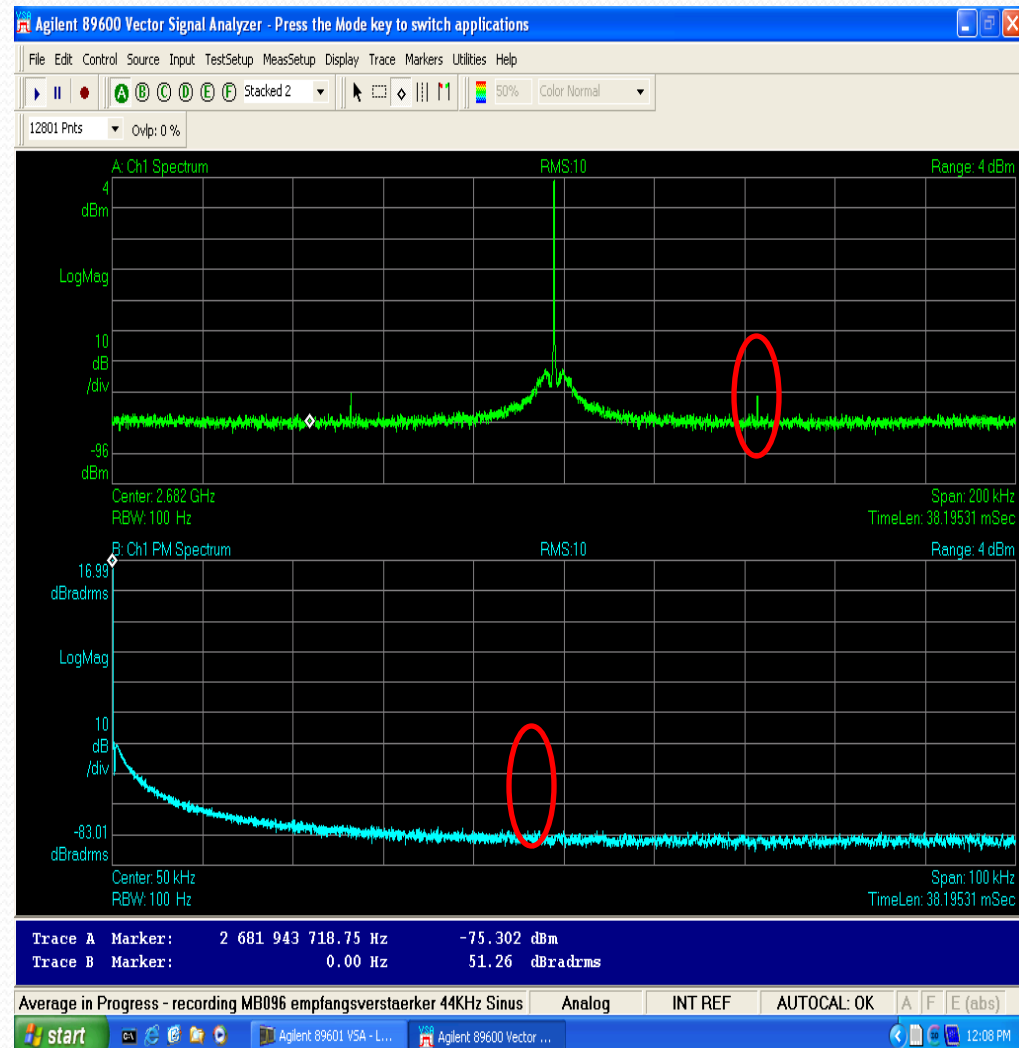

Supply voltage AM modulation test sender

- The sender is more sensitive to the 44KHz signal applied to the supply voltage
- The PM-Demodulation shows a clear peak
- This proves that PM can be caused by the supply voltage

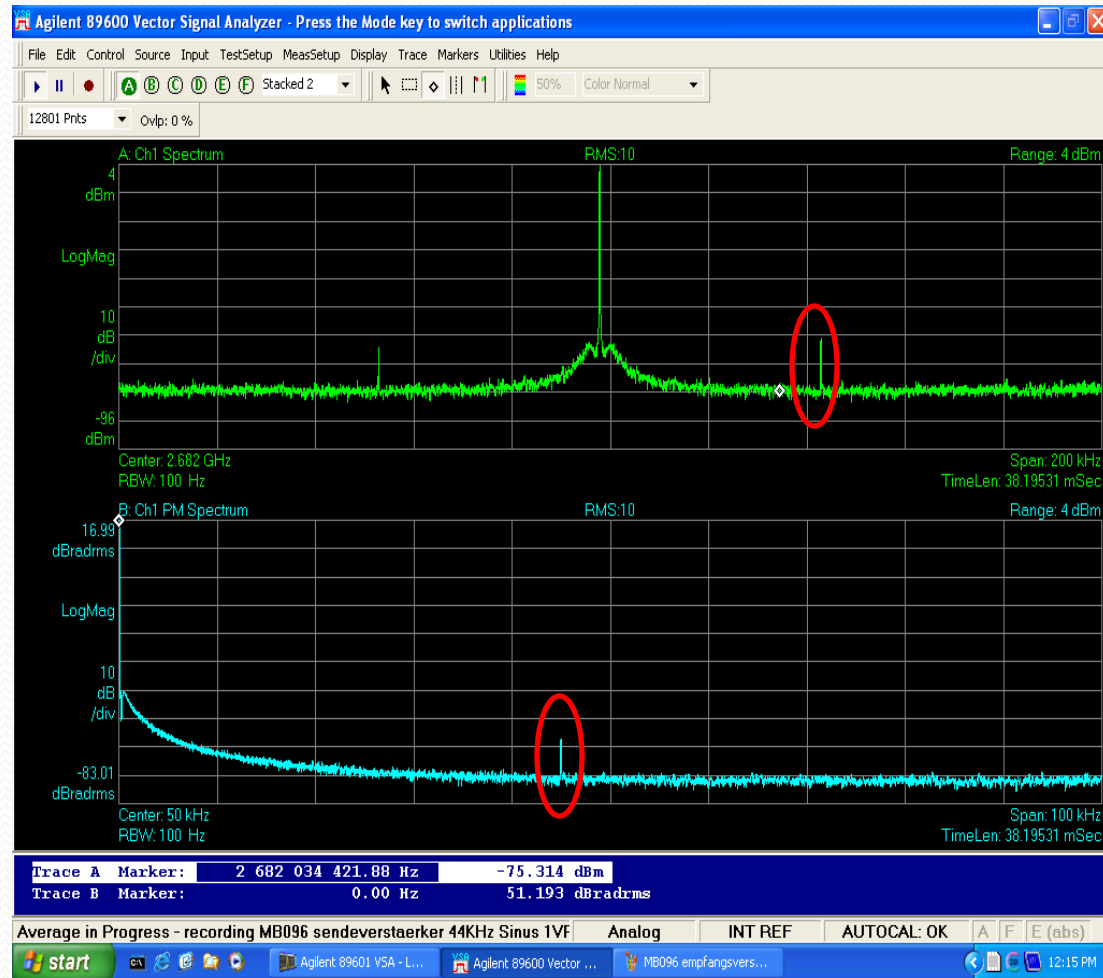

Supply voltage AM modulation transmission with beam

- To check to the measurements cross checks with beam on Friday (19.6. after MD) have been performed
- The applied modulation was in this case at 42KHz and both signals have been compared
- The 44khz line is narrow and therefore it can't caused by beam harmonics in the GHz range

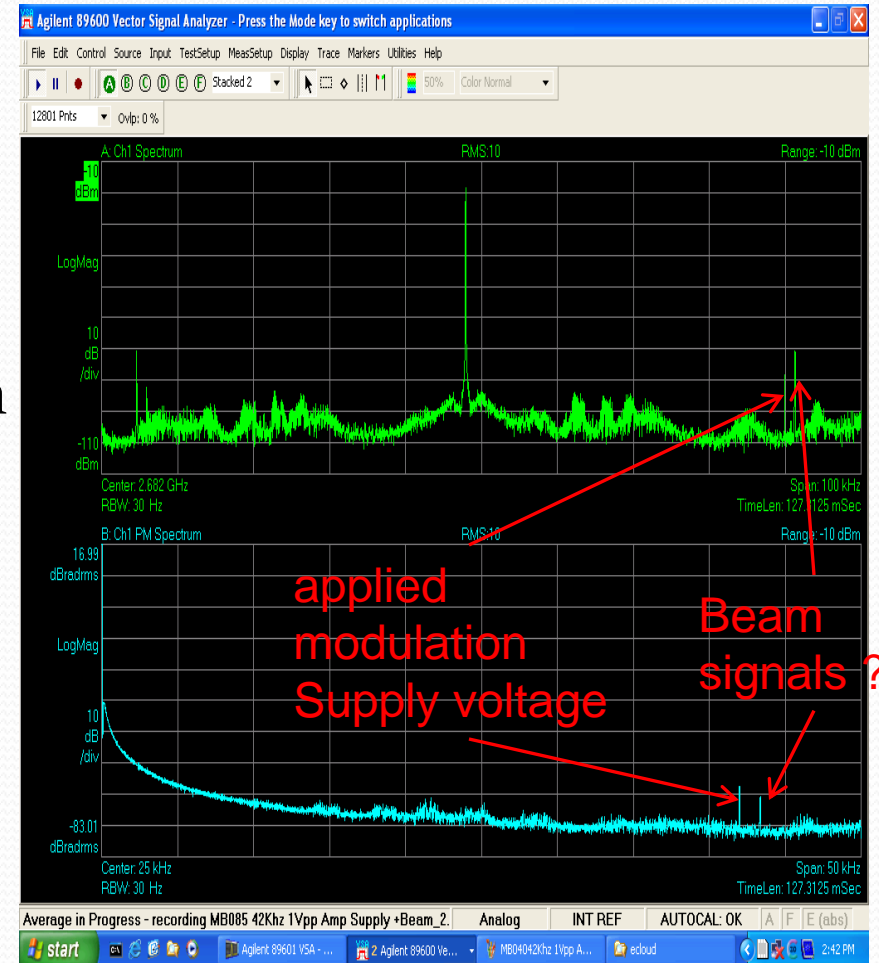

AM-PM conversion

- It's very likely that most of our PM-Signal is caused by AM modulation of the power amplifier in the sender branch
- This is due to the fact that the supply filter start somewhere around 1MHz and the regulation circuit of the amplifier seems to not work perfect at these frequencies
- The AM caused by the beam induced signals on the power supply convert to PM caused by the slope in the HTF

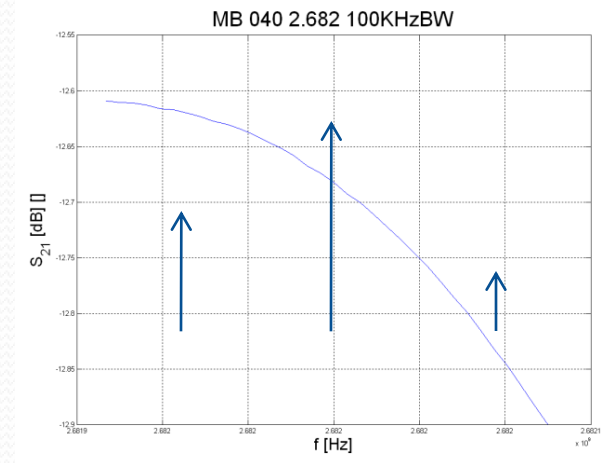

approx. 0.2 dB
difference
between sidebands

Preliminary conclusion

- We have seen a significantly longer PM-signal decay for the uncoated magnet as compared to the coated one during the same cycle during flat bottom before scrubbing
- After scrubbing no difference was noticed any more
- However there are still a number uncertainties and questionmarks (such as parasitic 44KHz in the power supply) to be clarified and mitigated

Uncoated MB286 4971

A: Ch1 Spectrum

Range: 10 dBm

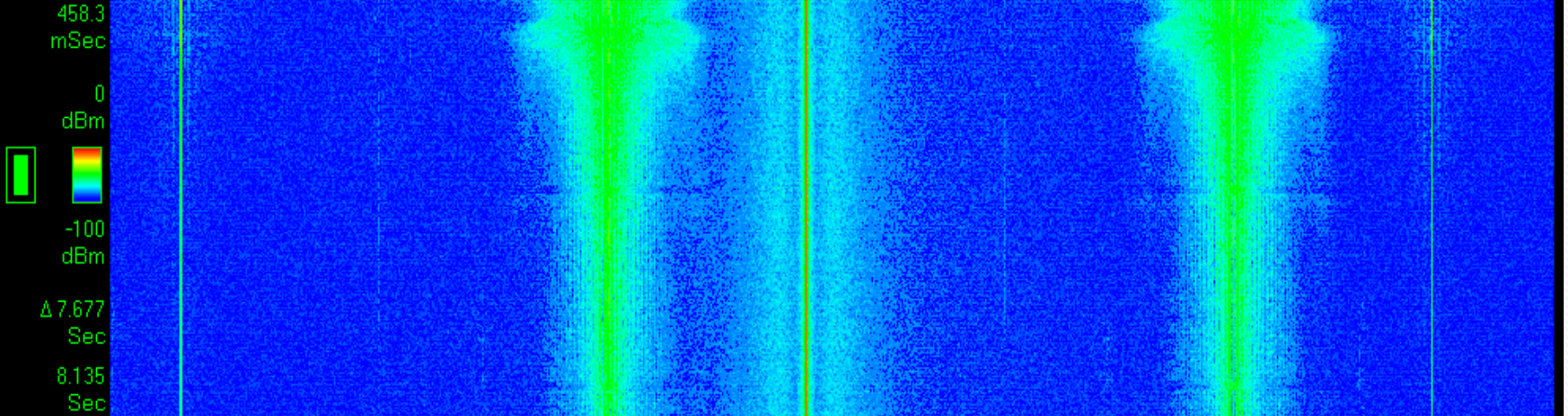

Center: 2.682 GHz

RBW: 30 Hz

Span: 100 kHz

TimeLen: 127.3125 mSec

B: Ch1 PM Spectrum

Range: 10 dBm

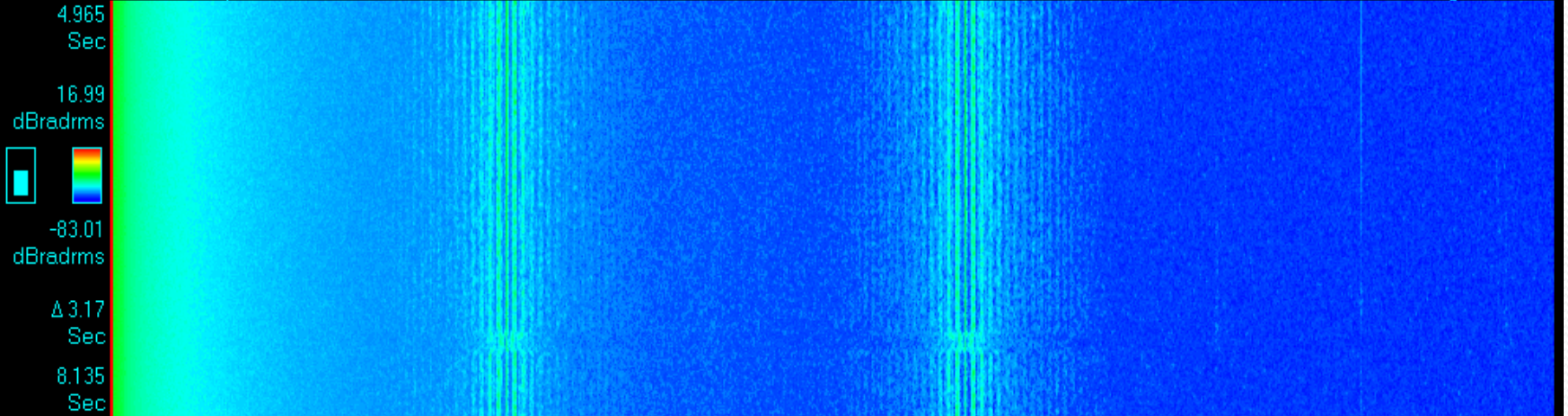

Center: 25 kHz

RBW: 30 Hz

Span: 50 kHz

TimeLen: 127.3125 mSec

Coated MB040 4971

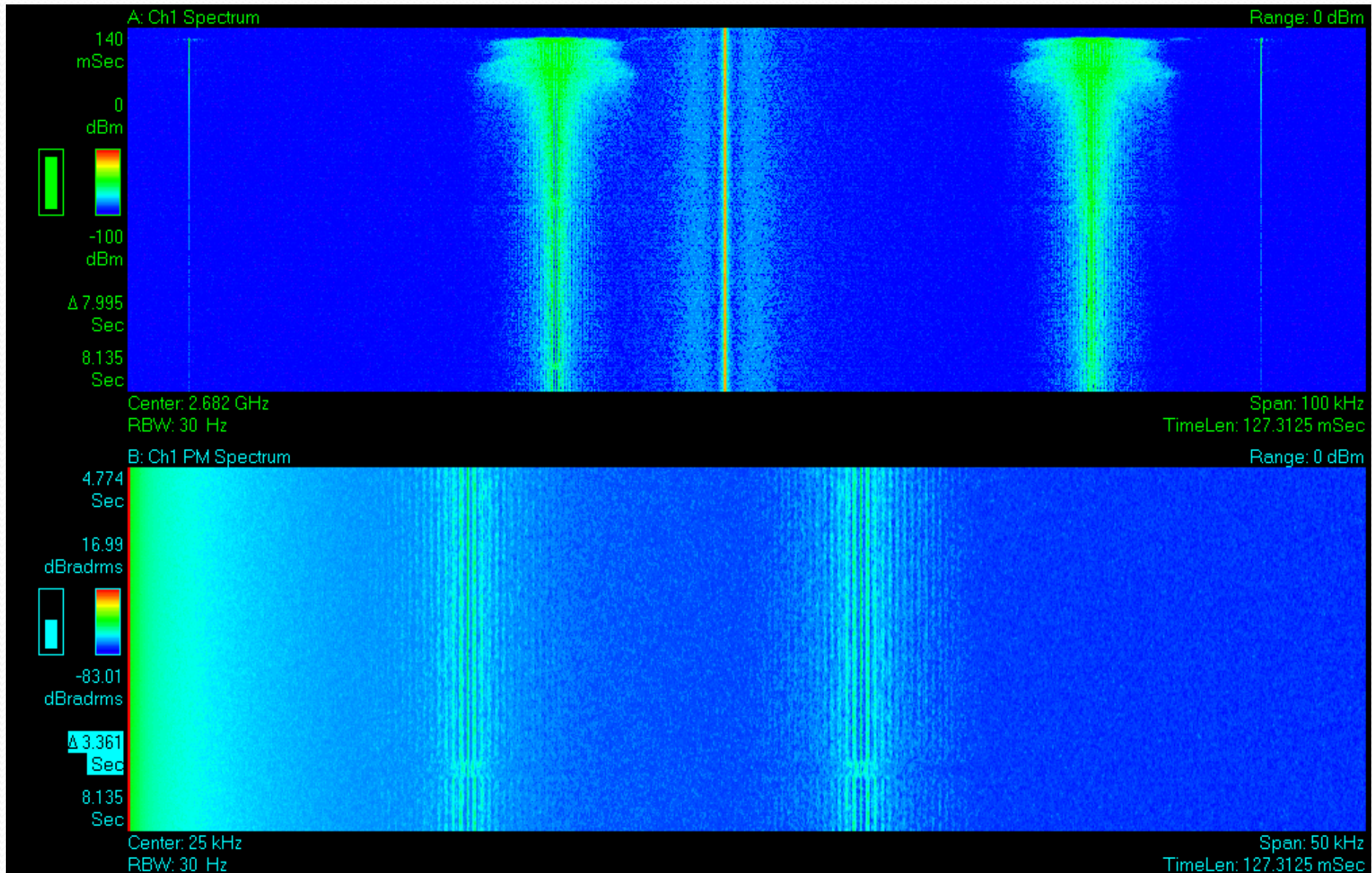

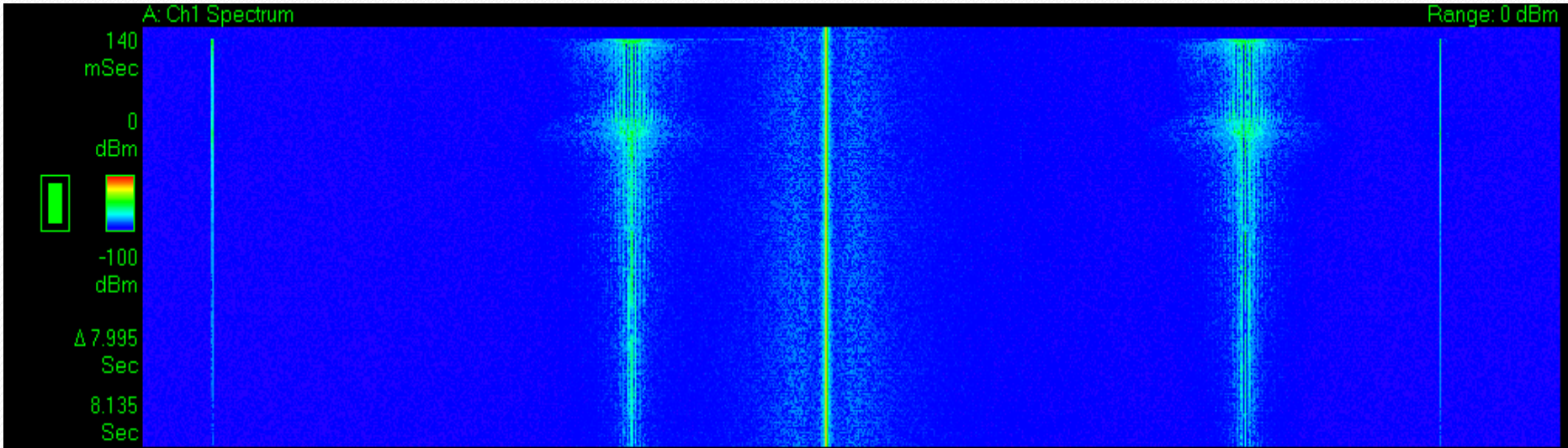

Center: 2.682 GHz
RBW: 30 Hz

Span: 100 kHz
TimeLen: 127.3125 mSec

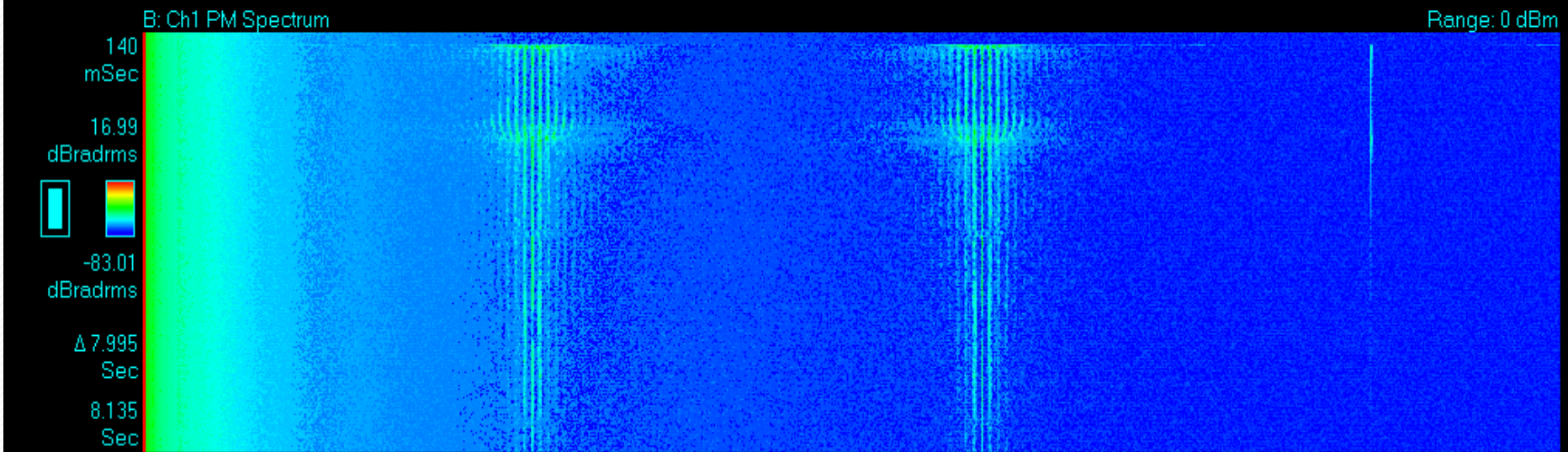

Center: 25 kHz
RBW: 30 Hz

Span: 50 kHz
TimeLen: 127.3125 mSec

A: Ch1 Spectrum

Range: 10 dBm

1.146
Sec

10
dBm



-90
dBm

Δ 6.989
Sec

8.135
Sec

Center: 2.682 GHz

RBW: 30 Hz

Span: 100 kHz

TimeLen: 127.3125 mSec

B: Ch1 PM Spectrum

Range: 10 dBm

140
mSec

16.99
dBdrms



-83.01
dBdrms

Δ 7.995
Sec

8.135
Sec

Center: 25 kHz

RBW: 30 Hz

Span: 50 kHz

TimeLen: 127.3125 mSec

A: Ch1 Spectrum

Range: 6 dBm

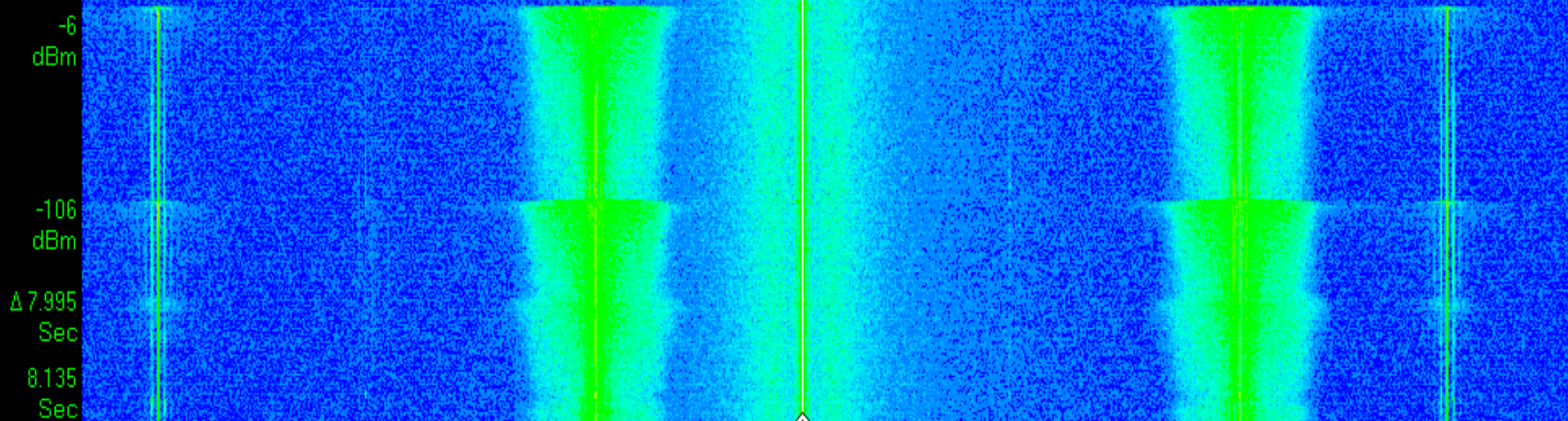

Center: 2.682 GHz
RBW: 30 Hz

Span: 100 kHz
TimeLen: 127.3125 mSec

B: Ch1 PM Spectrum

Range: 6 dBm

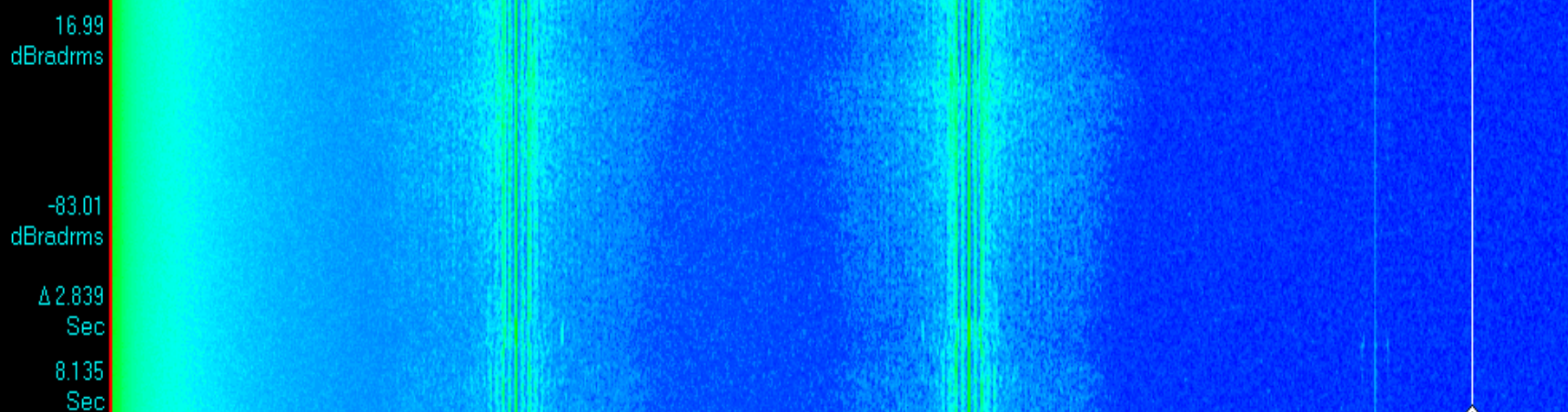

Center: 25 kHz
RBW: 30 Hz

Span: 50 kHz
TimeLen: 127.3125 mSec

A: Ch1 Spectrum

Range: -4 dBm

-4
dBm

-104
dBm

Δ 7.766
Sec

8.135
Sec

Center: 2.682 GHz
RBW: 30 Hz

Span: 100 kHz
TimeLen: 127.3125 mSec

B: Ch1 PM Spectrum

Range: -4 dBm

16.99
dBdrms

-83.01
dBdrms

Δ 2.839
Sec

8.135
Sec

Center: 25 kHz
RBW: 30 Hz

Span: 50 kHz
TimeLen: 127.3125 mSec

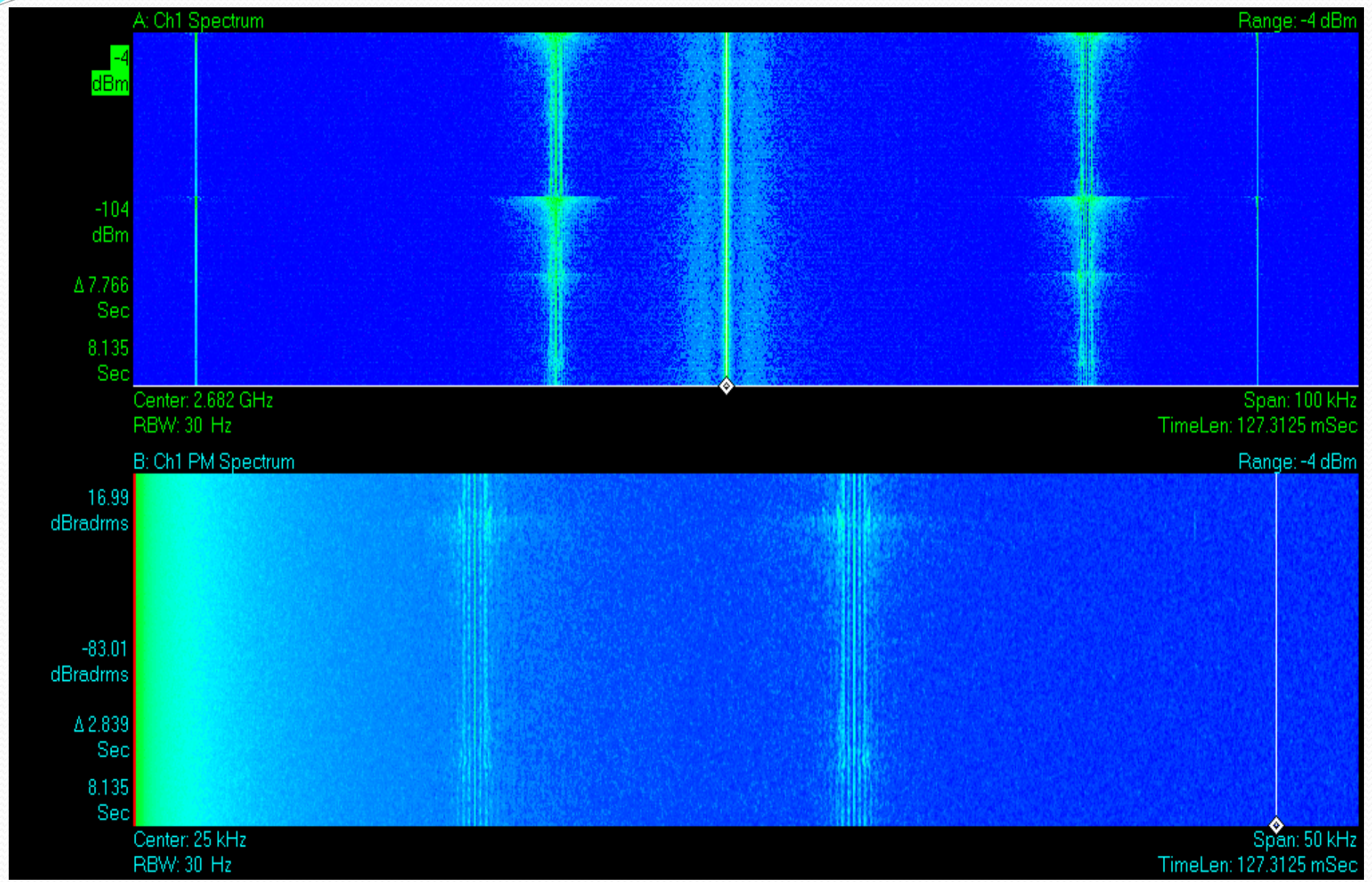

A: Ch1 Spectrum

Range: 10 dBm

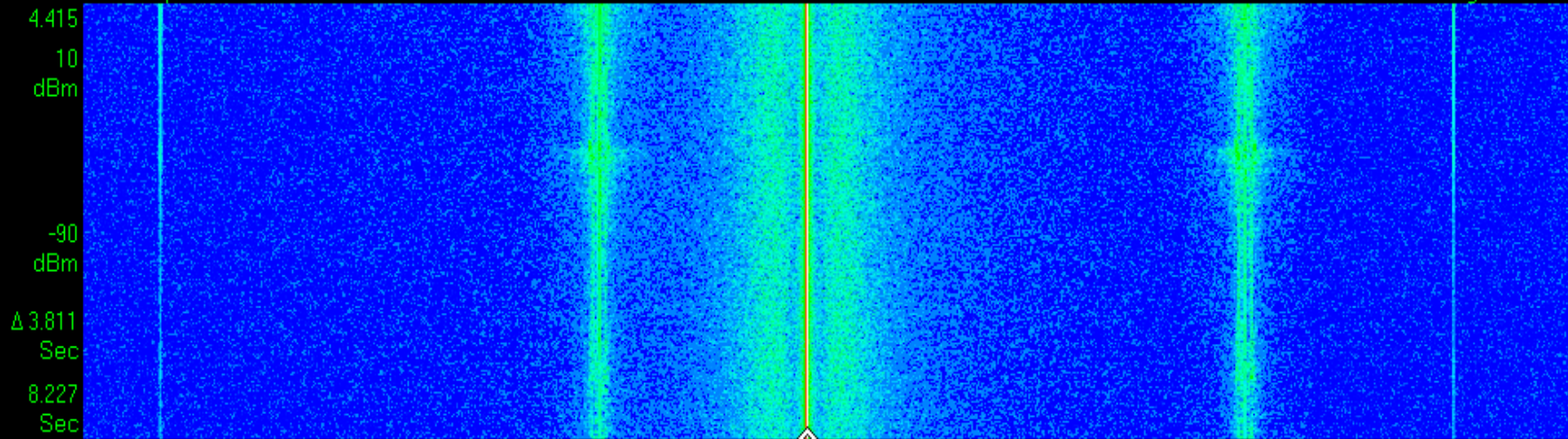

Center: 2.682 GHz
RBW: 99.9955 Hz

Span: 100 kHz
TimeLen: 38.19531 mSec

B: Ch1 PM Spectrum

Range: 10 dBm

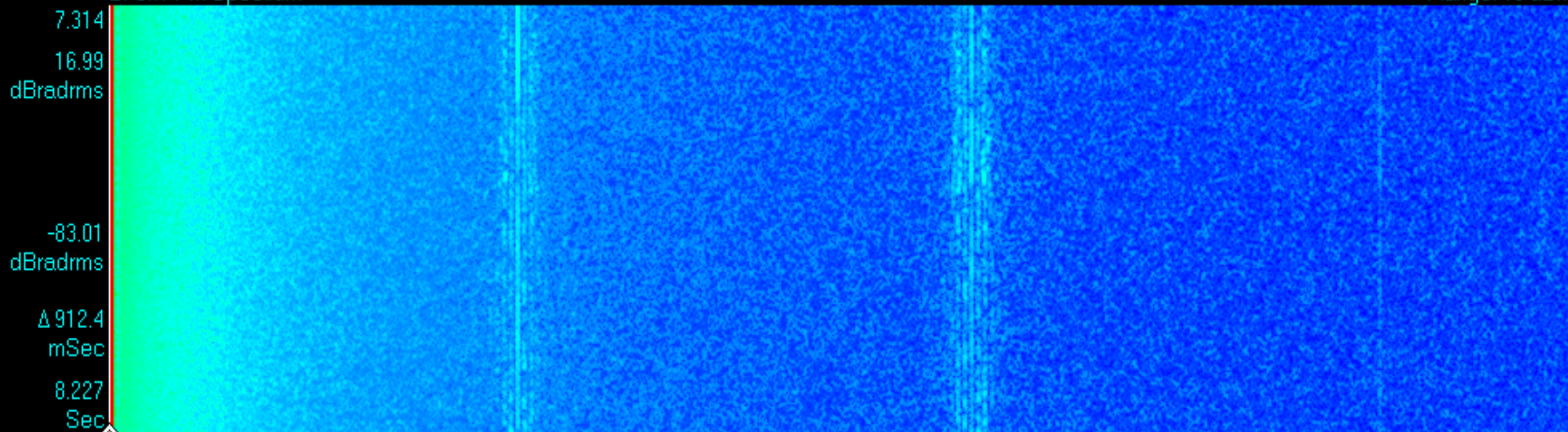

Center: 25 kHz
RBW: 99.9955 Hz

Span: 50 kHz
TimeLen: 38.19531 mSec